

# STÜCKLISTE „AvantGarde®“ A4, A8

Stand Oktober 2021 | technische Änderungen vorbehalten



QUALITÄT AUS  
ÖSTERREICH

1

## Paket Nr. 1

Tür - Paket · Doorpackage · Carton de portes · Deurpakket · Kit de puerta · Pacco porta · Dørpakke

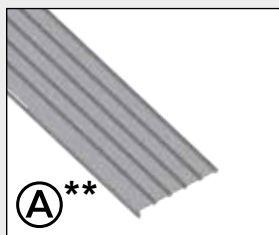

A\*\*

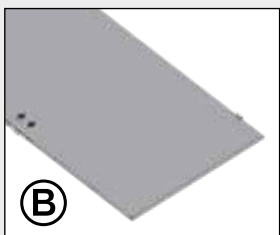

B

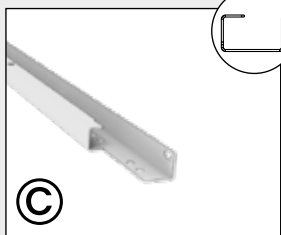

C



D3

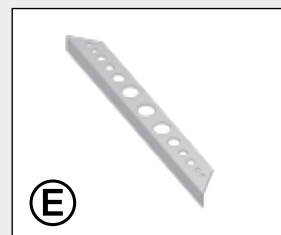

E

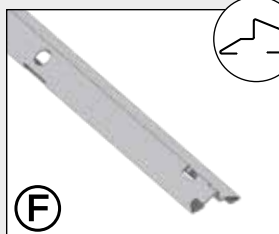

F

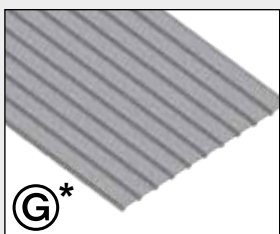

G\*

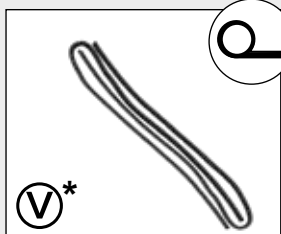

V\*



D4



H

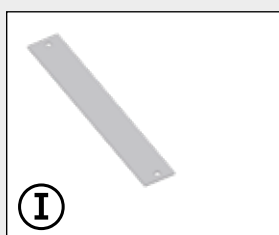

I



J

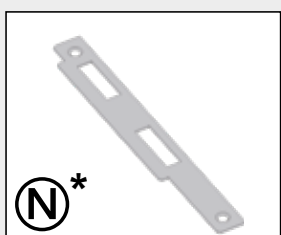

N\*

### \*Teil entfällt bei der Doppeltür

- GB Part not required when double doors are fitted
- FR La pièce est supprimée pour la double portes.
- NL Deel vervalt bij de dubbele deur
- ES Pieza no es necesaria en caso de puerta doble
- IT Pezzo non può essere utilizzato per la variante porta a due battenti
- DK Del ikke nødvendig med dobbeltdør

### \*\*Teil entfällt bei der Doppeltür A4

- GB Part not required when double doors A4 are fitted
- FR La pièce est supprimée pour la double portes A4.
- NL Deel vervalt bij de dubbele deur A4.
- ES Pieza no es necesaria en caso de puerta doble A4.
- IT Pezzo non può essere utilizzato per la variante porta a due battenti A4.
- DK Del ikke nødvendig med dobbeltdør A4.

## Zusatzteile Doppeltür

Double door package · Carton de double portes · Dubbeldeurpakket · Pacco porta doppia · Kit de puerta adicional · Ekstradele dobbeltdør



ZA



K

### Nur für Größe A4

Only for size A4  
Uniquement pour taille A4  
Alleen voor maat A4  
Solo para los tamaños A4  
Solo per misura A4  
Kun for størrelse A4

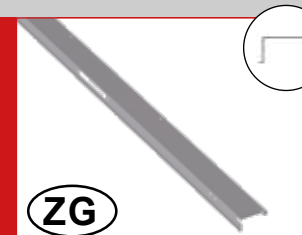

ZG



2

## Paket Nr. 2

Seitenwand - Paket · Side panel package · Carton de parois latérales · Zijwandpakket · Panel la teral · Pacco pareti laterali · Sidepladepakke

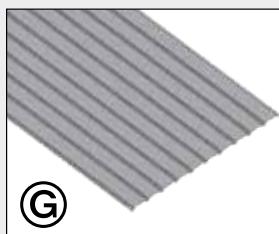

G

2a

### Paket Nr. 2a

Seitenwand - Paket · Side panel package · Carton de parois latérales · Zijwandpakket · Panel lateral · Pacco pareti laterali · Sidepladepakke

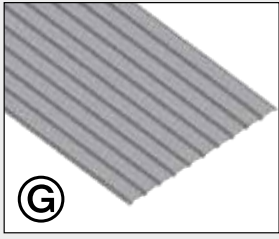

3

### Paket Nr. 3

Profil - Paket · Profile package · Carton de profils · Profielpakket · Kit de perfiles · Pacco profili · Profilpakke

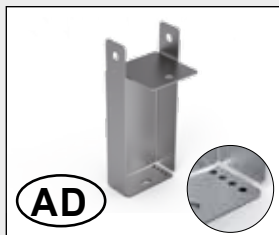
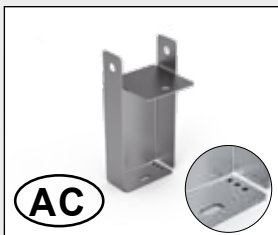
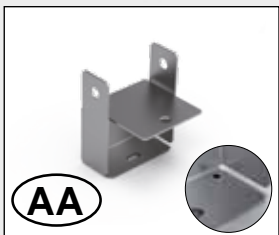
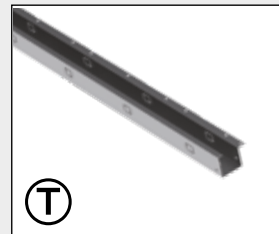
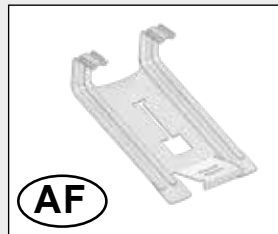
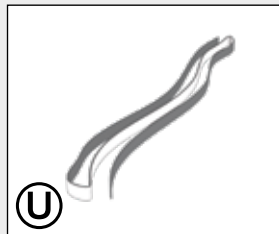
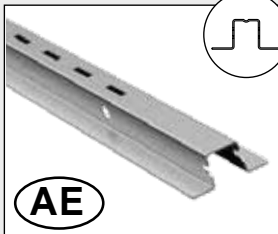
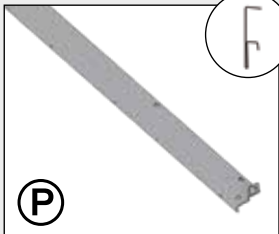
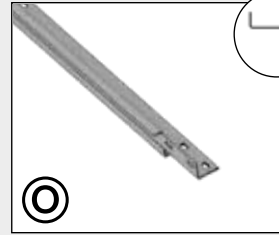
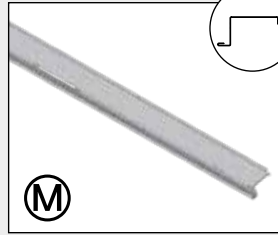
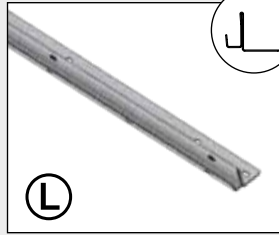

3a

### Paket Nr. 3a

Profilzusatz - Paket · Additional profile package · Carton supplémentaire de profils · Profielpakket · Paquete de perfiles adicional · Pacco profili · Profiltillægspakke

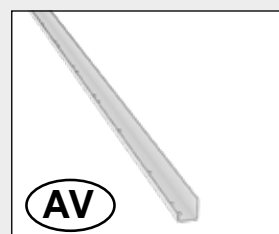
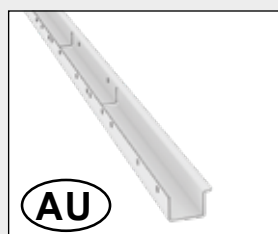
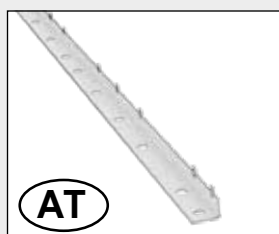
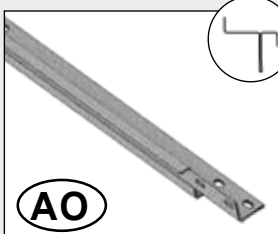
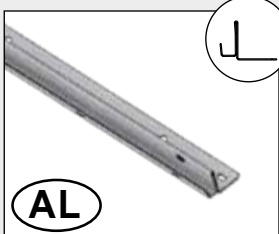

4

### Paket Nr. 4

Dach - Paket · Roof package · Carton du toit · Dakpakket · Paquete de cubierta · Pacco del tetto · Tagpakke

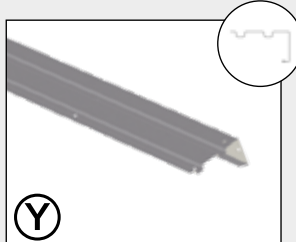
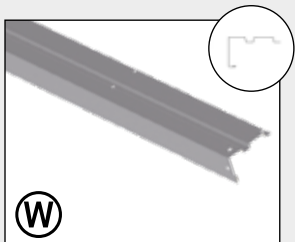

4a

**Paket Nr. 4a**

Dachverlängerungspaket · Roof extension package · Carton extension de toit · Dakpakket · Paquete de ampliación del techo · Pacchetto di estensione del tetto · Pakke med tagforlængelse

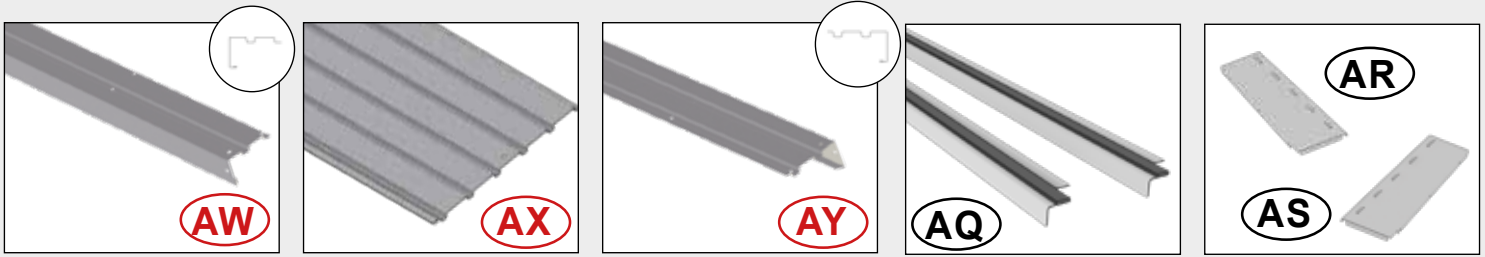

5

**Paket Nr. 5**

Dach-Profilpaket · Top profile package · Carton de profils de toit · Dakprofielpakket · Kit de perfiles de tejado · Pacco profili del tetto · Tagprofilpakke

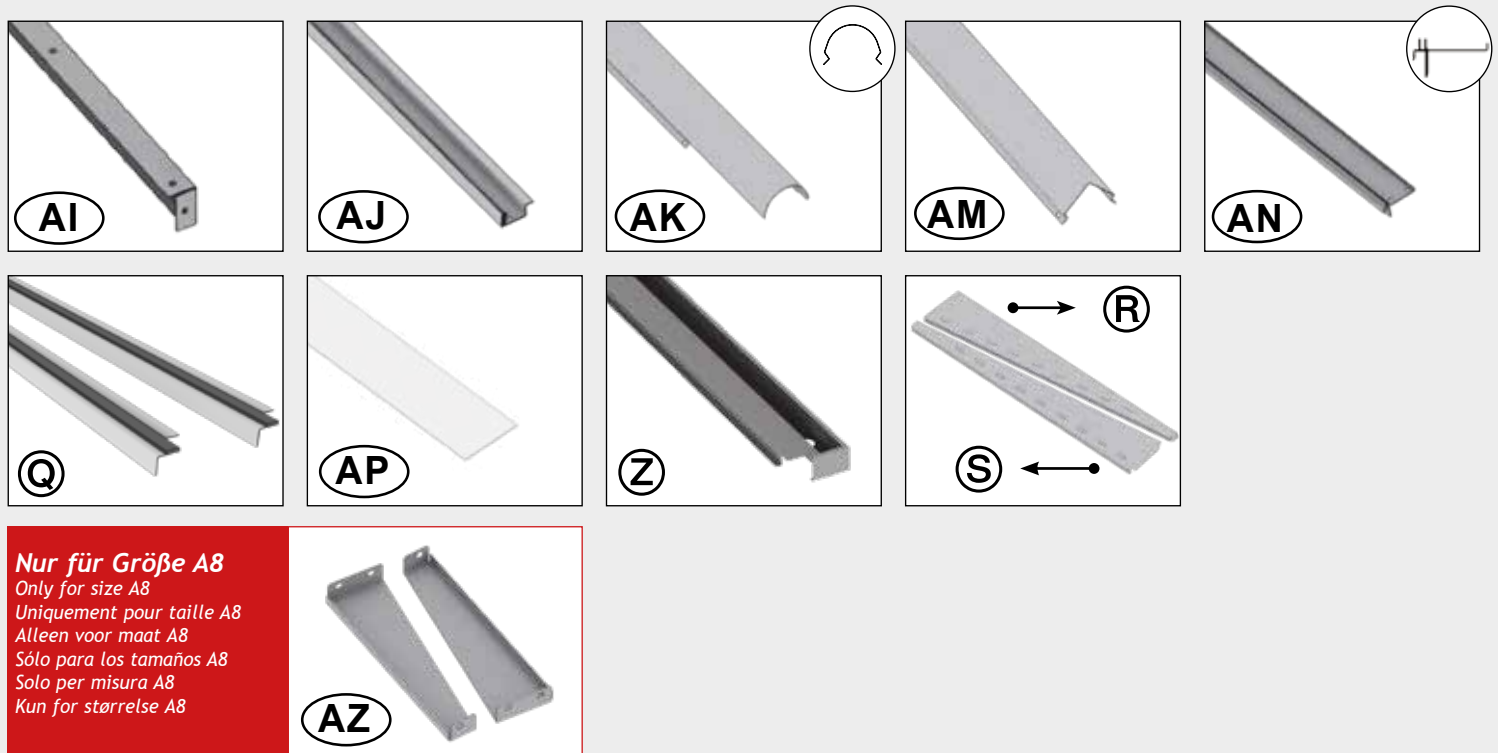
**Nur für Größe A8**

Only for size A8

Uniquement pour taille A8

Alleen voor maat A8

Sólo para los tamaños A8

Solo per misura A8

Kun for størrelse A8

AZ

**Bodenrahmen**

Floor Frame · Cadre de sol · Bodemframe · Marco de suelo · Telaio perimetrale · Bundramme

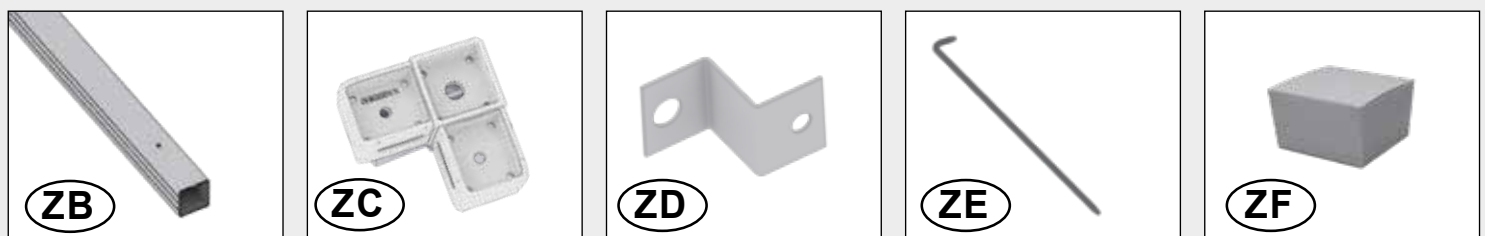

|  |           |                |                              |                                    | A4   | A8   |
|--|-----------|----------------|------------------------------|------------------------------------|------|------|
| Paket Nr.  | Pos.-Nr.  | Artikel-Nummer | Maße (mm)                    | Artikelname                        | Stk. | Stk. |
|  <p><b>Paket Nr. 1</b><br/>Standardtürpaket<br/>8*011</p> | <b>A</b>  | XH*00101       | /                            | Vorderwandelement                  | 2    | 2    |
|  | <b>B</b>  | EH*00220       | /                            | Tür rechts komplett                | 1    | 1    |
|  | <b>C</b>  | XH701116       | 984                          | Versteifung Kopfprofil             | 1    | 1    |
|  | <b>E</b>  | X3*00430       | /                            | Werkzeughalter                     | 2    | 2    |
|  | <b>F</b>  | XH701106       | 798                          | Türbodenschwelle                   | 1    | 1    |
|  | <b>G</b>  | X3*00100       | /                            | Seitenwandelement                  | 1    | 1    |
|  | <b>V</b>  | X3000112       | /                            | Gummiprofil                        | 1    | 1    |
|  |           | XH780011       |                              | Kleinteilpaket                     | 1    | 1    |
|  | <b>D4</b> | XH700547       | /                            | Kleinteilepäckchen für Standardtür | 1    | 1    |
|  | <b>H</b>  | X3000224       | /                            | Gasdruckfeder 75N                  | 1    | 1    |
|  | <b>I</b>  | XH700248       | /                            | Abdeckblech für Türanschlagprofil  | 1    | 1    |
|  | <b>D3</b> | XH700241       | /                            | Türdrücker                         | 1    | 1    |
|  | <b>J</b>  | E3000227       | /                            | Gasfederkonsole für Tür            | 1    | 1    |
|  | <b>N</b>  | XH700246       | /                            | Schließblech für Tür rechts        | 1    | 1    |
| -  | XH700245  | /              | Profilzylinder mit Schlüssel | 1                                  | 1    |      |

|   |           |          |      |   | A4 | A8 |
|---|-----------|----------|------|---|----|----|
|  <p><b>Paket Nr.1</b><br/>Doppeltürpaket<br/>8*021</p> | <b>A</b>  | XH*00101 | /    | Vorderwandelement                       |    | 2  |
|   | <b>B</b>  | EH*00220 | /    | Tür rechts komplett                     |    | 1  |
|   | <b>C</b>  | XH702116 | 1784 | Versteifung Kopfprofil                  |    | 1  |
|   | <b>E</b>  | X3*00430 | /    | Werkzeughalter                          |    | 2  |
|   | <b>F</b>  | XH702106 | 1596 | Türbodenschwelle                        |    | 1  |
|   | <b>ZA</b> | EH*00240 | /    | Türflügel links komplett                |    | 1  |
|   |           | XH780021 |      | Kleinteilpaket                          |    | 1  |
|   | <b>D4</b> | XH700548 | /    | Kleinteilepäck. für Doppeltür/Zusatztür |    | 1  |
|   | <b>H</b>  | X3000224 | /    | Gasdruckfeder 75N                       |    | 2  |
|   | <b>I</b>  | XH700248 | /    | Abdeckblech für Türanschlagprofil       |    | 2  |
|   | <b>D3</b> | XH700241 | /    | Türdrücker                              |    | 1  |
|   | <b>J</b>  | E3000227 | /    | Gasfederkonsole für Tür                 |    | 2  |
|   | <b>K</b>  | EH700250 | /    | Drehknopf innen mit Rosette             |    | 1  |
|   | -         | XH700245 | /    | Profilzylinder mit Schlüssel            |    | 1  |

|  |           |          |                              |   | A4 | A8 |
|--|-----------|----------|------------------------------|---|----|----|
|  <p><b>Paket Nr.1</b><br/>Doppeltürpaket<br/>schmal<br/>8*031</p> | <b>ZG</b> | XH*04101 | /                            | Vorderwandelement                       | 2  |    |
|  | <b>B</b>  | EH*00220 | /                            | Tür rechts komplett                     | 1  |    |
|  | <b>C</b>  | XH704116 | 1624                         | Versteifung Kopfprofil                  | 1  |    |
|  | <b>E</b>  | X3*00430 | /                            | Werkzeughalter                          | 2  |    |
|  | <b>F</b>  | XH704106 | 1436                         | Türbodenschwelle                        | 1  |    |
|  | <b>ZA</b> | EH*04240 | /                            | Türflügel links komplett                | 1  |    |
|  |           | XH780021 |                              | Kleinteilpaket                          | 1  |    |
|  | <b>D4</b> | XH700548 | /                            | Kleinteilepäck. für Doppeltür/Zusatztür | 1  |    |
|  | <b>H</b>  | X3000224 | /                            | Gasdruckfeder 75N                       | 2  |    |
|  | <b>I</b>  | XH700248 | /                            | Abdeckblech für Türanschlagprofil       | 2  |    |
|  | <b>D3</b> | XH700241 | /                            | Türdrücker                              | 1  |    |
|  | <b>J</b>  | E3000227 | /                            | Gasfederkonsole für Tür                 | 2  |    |
|  | <b>K</b>  | EH700250 | /                            | Drehknopf innen mit Rosette             | 1  |    |
| -  | XH700245  | /        | Profilzylinder mit Schlüssel | 1                                       |    |    |

|  |          |          |   |                   | A4 | A8 |
|--|----------|----------|---|-------------------|----|----|
|  <p><b>Paket Nr.2</b><br/>Seitenwandpaket<br/>8*022 (A4)<br/>8*032 (A8)</p> | <b>G</b> | X3*00100 | / | Seitenwandelement | 5  | 7  |

\* bei Doppeltür schmal wird 8\*022 2x benötigt

|  |                          |   |          |   | A4                | A8  |
|--|--------------------------|---|----------|---|-------------------|-----|
|  | <b>Paket Nr.2a</b>       |   |          |   |                   |     |
|  | Seitenwandpaket<br>8*052 | G | X3*00100 | / | Seitenwandelement | 4 4 |

\*bei Doppeltür schmal entfällt dieses Paket beim A4

|   |           |          |            |                           | A4 | A8 |
|---|-----------|----------|------------|---------------------------|----|----|
|  | <b>D1</b> | X3000580 | /          | Kleinteilepaket universal | 1  | 1  |
|   | <b>D2</b> | X3000559 | /          | Schraubenpaket            | 1  | 1  |
|   | <b>L</b>  | X3002104 | 1710       | Bodenprofil               | 2  |    |
|   |           | X3003104 | 2510       |                           | 2  | 4  |
|   | <b>M</b>  | XH700111 | /          | Türanschlagprofil         | 2  | 2  |
|   | <b>O</b>  | X3003107 | 2510       | Kopfprofil links/rechts   | 2  | 2  |
|   | <b>P</b>  | X3002110 | 1760       | Kopfprofil hinten         | 1  |    |
|   |           | X3003110 | 2530       |                           |    | 1  |
|   | <b>AE</b> | XI701400 | /          | Regalsteher               | 2  | 2  |
|   | <b>T</b>  | X3001309 | 1730       | Dachträger                | 3  |    |
|   |           | X3004309 | 2530       |                           |    | 3  |
|   |           | X3000583 |            | Kleinteilepaket           | 1  | 1  |
|   |           | Y3025030 |            | Aufbauanleitung           | 1  | 1  |
| <b>AH</b>   | XI700402  | /        | Regalboden | 2                         | 2  |    |

|   |           |          |      |                               | A4 | A8 |
|---|-----------|----------|------|-------------------------------|----|----|
|  | <b>AL</b> | X3013104 | 800  | Bodenprofilverlängerung       | 2  | 2  |
|   | <b>AO</b> | X3013107 | 800  | Kopfprofilverlängerung        | 2  | 2  |
|   | <b>AT</b> | X3000124 | 1220 | Verbindungswinkel Bodenprofil | 2  | 2  |
|   | <b>AU</b> | X3000321 | 1240 | Verbindungswinkel Kopfprofil  | 2  | 2  |
|   | <b>AV</b> | X3000115 | 1615 | Kopfprofilversteifung         | 2  | 2  |

|   |          |          |      |                  | A4 | A8 |
|---|----------|----------|------|------------------|----|----|
|  | <b>W</b> | X3*04301 | 2150 | Dachblech links  | 1  | 1  |
|   | <b>X</b> | X3*04300 | 2150 | Dachblech mitte  | 4  | 6  |
|   | <b>Y</b> | X3*04302 | 2150 | Dachblech rechts | 1  | 1  |

|   |           |          |      |                                      | A4 | A8 |
|---|-----------|----------|------|--------------------------------------|----|----|
|  | <b>AW</b> | X3*24301 | 1760 | Dachblechverlängerung li             | 1  | 1  |
|   | <b>AX</b> | X3*24300 | 1760 | Dachblechverlängerung mi             | 4  | 6  |
|   | <b>AY</b> | X3*24302 | 1760 | Dachblechverlängerung re             | 1  | 1  |
|   | <b>AR</b> | E3*13313 | 800  | Giebel-Verlängerung links            | 1  | 1  |
|   | <b>AS</b> | E3*13314 | 800  | Giebel-Verlängerung rechts           | 1  | 1  |
|   | <b>AQ</b> | E3*13109 | 800  | Abdeckleiste Verlängerung Kopfprofil | 2  | 2  |

|   |           |          |                                 |                             | A4 | A8 |
|---|-----------|----------|---------------------------------|-----------------------------|----|----|
|  | <b>Z</b>  | E3*02303 | 1800                            | Dachrinne                   | 1  |    |
|   |           | E3*03303 | 2600                            |                             |    | 1  |
|   | <b>AI</b> | X3*02305 | 1800                            | Dachblecheinfassung         | 1  |    |
|   |           | X3*03305 | 2600                            |                             |    | 1  |
|   | <b>AJ</b> | X3*02310 | 1710                            | Acrylgaseinfassung          | 1  |    |
|   |           | X3*03310 | 2530                            |                             |    | 1  |
|   | <b>AK</b> | X3*03102 | 2180                            | Eckverkleidung vorne        | 2  | 2  |
|   | <b>AM</b> | X3*00105 | 1880                            | Eckverkleidung hinten       | 2  | 2  |
|   | <b>AN</b> | X3*02108 | 1710                            | Alu-Kopfprofil vorne        | 1  |    |
|   |           | X3*03108 | 2510                            |                             |    | 1  |
|   | <b>Q</b>  | X3*23109 | 2480                            | Abdeckleiste für Kopfprofil | 2  | 2  |
|   | <b>AP</b> | X3001312 | 1730                            | Acrylglas                   | 1  |    |
|   |           | X3004312 | 2530                            |                             |    | 1  |
|   | <b>R</b>  | E3*03313 | 2520                            | Giebelblech links           | 1  | 1  |
|   | <b>S</b>  | E3*03314 | 2520                            | Giebelblech rechts          | 1  | 1  |
| <b>AZ</b>   | X3*03308  | /        | Verbindung Kopfprofil-Dachblech |                             | 2  |    |
|   | X4*00460  | /        | Ausbesserungslackstift          | 1                           | 1  |    |

| Farbe               | Auswahl Artikelnummer (gilt nicht für Verkaufartikelnummer) |                   |
|---------------------|---|-------------------|
| silber-metallic     | * ..... → 3 .....   | # ..... → 5 ..... |
| dunkelgrau-metallic | * ..... → 4 .....   | # ..... → 7 ..... |
| quarzgrau-metallic  | * ..... → 8 .....   | # ..... → 9 ..... |

|  |           |          |      |                                | A4 | A8 |
|--|-----------|----------|------|--------------------------------|----|----|
| <b>Bodenrahmen</b><br>41081 (A4)<br>41061 (A8) | <b>ZB</b> | E3000608 | 1640 | Formrohr gelocht               | 2  |    |
|  |           | E3000609 | 2440 |                                |    | 2  |
|  |           | E3000614 | 3240 |                                | 2  | 2  |
|  | <b>ZC</b> | X4000610 | /    | Eckverbindung-Bodenrahmen      | 4  | 4  |
|  | <b>ZD</b> | X4000611 | /    | Bodenbefestigungswinkel        | 8  | 8  |
|  | <b>ZE</b> | X4000612 | /    | Bodenanker                     | 12 | 12 |
|  |           | Y4041001 |      | Aufbauanleitung                | 1  | 1  |
|  | <b>ZF</b> | X3000561 | /    | Schraubenpaket für Bodenrahmen | 1  | 1  |

|                                    |  |          |   |                 | A4 | A8 |
|------------------------------------|--|----------|---|-----------------|----|----|
| <b>Kleinteilepaket</b><br>X3000580 |  | x4000425 | / | Gerätehalter    | 4  | 4  |
|                                    |  | X3000550 | / | Kleinteilepaket | 1  | 1  |
|                                    |  | X3000451 | / | Moosgummi       | 2  | 2  |
|                                    |  | X3000552 | / | Schraubenpaket  | 1  | 1  |

|   |           |                    |                                     |                                    |      | A4   | A8 |
|---|-----------|--------------------|-------------------------------------|------------------------------------|------|------|----|
| Paket Nr.   | Pos.-Nr.  | Artikel-<br>Nummer | Maße<br>(mm)                        | Artikelname                        | Stk. | Stk. |    |
| <b>Zusatztür</b><br>8*002<br>bestehend aus<br>8*011 & 83003 | <b>A</b>  | XH*00101           | /                                   | Vorderwandelement                  | 2    | 2    |    |
|   | <b>B</b>  | EH*00220           | /                                   | Tür rechts komplett                | 1    | 1    |    |
|   | <b>C</b>  | XH701116           | 984                                 | Versteifung Kopfprofil             | 1    | 1    |    |
|   | <b>E</b>  | X3*00430           | /                                   | Werkzeughalter                     | 2    | 2    |    |
|   | <b>F</b>  | XH701106           | 798                                 | Türbodenschwelle                   | 1    | 1    |    |
|   | <b>G</b>  | X3*00100           | /                                   | Seitenwandelement                  | 1    | 1    |    |
|   | <b>V</b>  | X3000112           | /                                   | Gummiprofil                        | 1    | 1    |    |
|   |           | XH780011           |                                     | Kleinteilepaket                    | 1    | 1    |    |
|   | <b>D4</b> | XH700547           | /                                   | Kleinteilepäckchen für Standardtür | 1    | 1    |    |
|   | <b>H</b>  | X3000224           | /                                   | Gasdruckfeder 75N                  | 1    | 1    |    |
|   | <b>I</b>  | XH700248           | /                                   | Abdeckblech für Türanschlagprofil  | 1    | 1    |    |
|   | <b>D3</b> | XH700241           | /                                   | Türdrücker                         | 1    | 1    |    |
|   | <b>J</b>  | E3000227           | /                                   | Gasfederkonsole für Tür            | 1    | 1    |    |
|   | <b>N</b>  | XH700246           | /                                   | Schließblech für Tür rechts        | 1    | 1    |    |
|   |           | 83003              |                                     | Zusatzpaket für Zusatztür          | 1    | 1    |    |
|   | XH700111  | /                  | Türanschlagprofil                   | 2                                  | 2    |      |    |
|   | XH701245  | /                  | Profilzylinder mit Schlüssel Muster | 2                                  | 2    |      |    |

| Paket Nr.                                   | Artikel-<br>Nummer | Artikelname                               | Stk. |
|---|--------------------|---|------|
| <b>D1</b><br>Kleinteilepäckchen<br>X3000550 | X2000065           | Steckschlüssel SW8 mit blauen Griff       | 1    |
|   | X2000064           | Gabelschlüssel SW8,SW10                   | 1    |
|   | A52076             | Sechskant Holzschraube 8x60mm             | 18   |
|   | A55007             | Beilagescheibe 8,4x18x2mm                 | 18   |
|   | A51050             | Dübel F10 schwarz                         | 18   |
|   | X4000424           | Mutter Dachrinnenauslauf                  | 2    |
|   | X3000615           | Abdeckung für Eckverkleidung              | 2    |
|   | X3000419           | Abdeckkappen d6x8mm, grauweiß, RAL 9002   | 150  |
|   | X2000040           | Handschuh                                 | 1    |
|   | Y1000006           | Schlüsselanhänger                         | 1    |
|   | A52012             | Drahtstift 5x140mm                        | 1    |
|   | X4000427           | Dachrinnenauslauf                         | 2    |
|   | X4000428           | O-Ring ø29x3                              | 2    |
|   | ZW020010           | Kapselheber                               | 1    |
|   | XI700403           | Sicherungsteil Regalboden und Wandschiene | 4    |



| Paket Nr.                               | Artikel-Nummer | Artikelname               | Stk. |
|---|----------------|---------------------------|------|
| <b>D2</b><br>Schraubenpaket<br>X3000559 | A52002         | Flachrundschraube M5x10mm | 90   |
|   | A52004         | Flachrundschraube M5x18mm | 5    |
|   | A2000033       | Mutter Niro M5            | 95   |
|   | A2000025       | Beilagscheibe 5,3x10x1mm  | 95   |



| Paket Nr.                               | Artikel-Nummer | Artikelname                       | Stk. |
|---|----------------|-----------------------------------|------|
| <b>D2</b><br>Schraubenpaket<br>X3000552 | A52002         | Flachrundschraube 5x10 mm         | 130  |
|   | A2000033       | Mutter NIRO M5                    | 130  |
|   | A2000025       | Beilagscheibe 5,3x10x1mm          | 150  |
|   | A4002017       | Sechskant Blechschraube A2 4,8x13 | 20   |

|   |           |          |   |                    | A4 | A8 |
|---|-----------|----------|---|--------------------|----|----|
| <b>Kleinteilepaket</b><br>GHA A4/A8<br>X3000583 | <b>AA</b> | X3001307 | / | Dachträgerstütze 1 | 2  | 2  |
|   | <b>AC</b> | X3003307 | / | Dachträgerstütze 3 | 2  | 2  |
|   | <b>AD</b> | X3004307 | / | Dachträgerstütze 4 | 2  | 2  |

|   |                |  |      | Standard-Tür | Doppel-Tür |
|---|----------------|--|------|--------------|------------|
| Paket Nr.   | Artikel-Nummer | Artikelname                              | Stk. | Stk.         | Stk.       |
| <b>D4</b><br><b>Kleinteilepäckchen</b><br>XH700547 (Standardtür)<br>XH700548<br>(Doppeltür/Zusatztür) | A4003026       | Senkschraube mit Kreuzschlitz A2 M5x12mm | 2    |              |            |
|   | A52002         | Flachrundschraube M5x10mm                | 20   | 22           | 22         |
|   | A2000033       | Mutter Niro M5                           | 22   | 22           | 22         |
|   | A2000025       | Beilagscheibe 5,3x10x1mm                 | 28   | 36           | 36         |
|   | A4002017       | Sechskant Blechschraube A2 4,8x13mm      | 6    | 14           | 14         |
|   | X3000203       | Edelstahlscharnier "A" männlich          | 1    | 2            | 2          |
|   | X3000204       | Edelstahlscharnier "B" männlich          | 1    | 2            | 2          |
|   | X2700225       | Kugelbolzen M8-29,5mm lang               | 1    | 2            | 2          |
|   | A4001007       | Federring 8,1x14,8x2 mm vz.              | 1    | 2            | 2          |
|   | A54009         | SK-Mutter M8 vz.                         | 1    | 2            | 2          |



| Paket Nr.                                      | Artikel-Nummer | Artikelname                      | Stk. |
|--|----------------|----------------------------------|------|
| <b>ZF</b><br><b>Schraubenpaket</b><br>X3000561 | X4000611       | Bodenbefestigungswinkel          | 4    |
|  | A51043         | Sechskant Blechschraube 6,3x22mm | 20   |
|  | A4005010       | Beilagscheibe 6,6 x 22 x 2       | 20   |





# AvantGarde Größen

