

Numarul 1 pentru case de gradina, cutii depozitare, jardiniere si mai mult



STORAGE
THE ORIGINAL
SOLUTIONS

HighLine® Marime H2, Metallic Cuart Grey

(cu urmatoarele accesorii : rama podea din aluminiu, panouri podea din aluminiu, usa dubla, cos depozitare pe usa si sistem fixare bicicleta)



 100% MADE IN AUSTRIA | CATALOG PRODUSE 2024



Satisfactia voastra
continua este
preocuparea
noastra principala

Dragi clienti,

Produsele Biohort iti ofera cea mai buna calitate, functionalitate si siguranta. Clientii nostrii apreciaza in special durabilitatea si faptul ca nu este necesara mentenanta la produsele noastre.

Casele de gradina de la Biohort si-au dovedit durabilitatea in cei peste 30 de ani de cand sunt pe piata. Suntem un producator din Austria iar operatorii nostrii sunt foarte bine scolarizati si foarte priceputi. Biohort foloseste pentru produsele sale doar materie prima de cea mai buna calitate de la furnizori verificati. Otelul de cea mai buna calitate pe care il utilizam este produs de catre fabricanti austrieci si germani de nivel mondial care se bucura de increderea producatorilor de masini germane premium. Acesta este motivul pentru care putem acorda clientilor cu toata increderea o garantie de 20 de ani impotriva coroziunii.

Lasa pe Biohort sa te ajute sa-ti indeplinesti visele in gradina fara nicio grija : cu solutiile pentru fundatie SmartBase si SmartBase^{PLUS}, livrarea gratuita si serviciile de asamblare, intregesc oferta noastra de solutii complete. Gasiti mai multe la pagina 5.

Designul sofisticat si un standard de calitate austriac, inalt, aplicat in procesul de productie creeaza produse de care va puteti bucura zeci de ani.

Garantam asta personal.

Dr. Josef Priglinger
Director

Inginer Diplomat
Maximilian Priglinger, MLS^{WU}
Director

4 Despre Biohort

8 Case de gradina

- 10 Neo
- 12 HighLine®
- 14 Panorama®
- 16 AvantGarde®, AvantGarde®ECO
- 18 Europa
- 20 Equipment Locker
- 22 Accesorii
- 26 BikeLift®
- 28 Soluțiile pentru fundație, SmartBase / SmartBase^{PLUS}



32 Modelul **CASA** NOVA



34 Cutii pentru depozitare in exterior

- 36 Dulap gradina Romeo®
- 38 StoreMax®
- 40 HighBoard
- 42 LoungeBox®
- 44 StyleBox®
- 46 LeisureTime Box



48 Depozitare bicicleta

- 50 MiniGarage
- 52 StoreMax®
- 54 HighBoard
- 26 BikeLift®



56 Depozitare pubele

- 58 Alex®
- 60 StoreMax®
- 62 HighBoard



64 Paturi de plantare

- 66 Pat supraînălțat
- 68 Pat de plantare Belvedere®
- 70 Accesorii
- 72 Sistem de jardiniere DaVinci®



74 Ajutoare in gradina

- 76 Paravan
- 78 Compostor MonAmi®
- 79 Garaj pentru robot de tuns iarba Charly®
- 80 WoodStock®



82 Informații detaliate

- 82 Calitate și durabilitate
- 84 Date tehnice
- 96 Informații privind prețurile codurilor QR



Livrare Gratuita

Livrare in 2 pana la 4 zile!* Livram direct la domiciliu fara costuri (livrare gratuita la domiciliu). Adresa trebuie sa fie accesibila pentru camion de 38 t (minim 3 m latime acces).

*pentru marfa pe stoc cu exceptia CasaNova®



Servicii de Montaj

Biohort este incantat sa te ajute sa gasesti o echipa de montaj care va asamble produsul intr-un mod profesionist. Mai multe informatii despre instalare si preturi recomandate gasiti la:

www.biohort.com/serviciu-de-montaj



Video Asamblare

Pentru a ajuta la asamblare am creat cateva filmulete pentru multe din produsele noastre. Le gasiti pe canalul de YouTube:

www.youtube.com/biohort



Pachetul de servicii complete **de la Biohort!**

Solutia completa

Garantam satisfactia pe termen lung pentru clientii nostrii cu produsele noastre durabile de calitate superioara. Adicional va oferim un pachet complet de service. Departamentul nostru **de servicii client** are grija intotdeauna de solicitarile dumneavoastra cat de repede posibil, indiferent de marimea produsului in cauza.

Prin **partenerii nostrii instruiti**, putem sa garantam confortul unei asamblari profesionale. Solutiile **pentru fundatie** SmartBase si SmartBase^{PLUS} sunt disponibile pentru toate tipurile de casa de gradina si se monteaza mai rapid si mai curat decat fundatiile scumpe de beton. Prin instrumentele noastre online precum **configuratorul de produs**, Biohort ofera cel mai complet service de pe piata!



Solutii Fundatie

Solutiile pentru fundatie Smart base si SmartBase^{PLUS} formeaza o fundatie stabila pentru casele de gradina Biohort si pentru Equipment Locker si MiniGaraj. Fundatia este rezistenta la furtuna si se instaleaza rapid.

Mai multe informatii la pagina 28-31 si la:

www.biohort.com/fundatie



Configurare Produs

Configuratia Biohort 3D iti permite sa vizualizezi cu cateva click-uri fiecare produs inclusiv accesoriile dorite si chiar calculeaza pretul final. Nu este suficient? functia de realitate augmentata iti permite sa pozitionezi virtual produsul direct in gradina ta de pe un telefon smart sau tableta.

www.biohort.com/configurator



Fabrica 3 St. Martin i. M.



Fabrica 1 Neufelden



Fabrica 2 Herzogsdorf

Totul **Made in Austria**

Biohort a produs intotdeauna in Austria si suntem mandrii de asta. Exista trei locatii mari in partea de vest a regiunii Mühlviertel din Austria Superioara. Am ales intentionat aceasta

regiune pentru ca are mana de lucru calificata. Acest lucru ne permite sa producem cea mai buna calitate.

Asta reprezentam noi!



Calitate

- 20 ani garantie, vezi pagina 82 pentru detalii
- Placa otel galvanizata la cald cu protectie de poliamida
- Suruburi si balamale din otel inoxidabil
- Nu necesita mentenanta pe parcursul vietii
- Etans impotriva apei de ploaie
- Productie in Austria



Stabilitate

- Grosime dubla a placii in comparatie cu furnizorii low cost
- Un design optimal
- Protectie la furtuna pana la o forta a vantului de 12 - 150 km/h*
- Sustine o cantitate mare de zapada* pana la 150 kg/m²



Functionalitate

- O gama larga de echipamente standard
- Prietenos cu utilizatorul
- O gama larga de accesorii
- O gama larga de aplicatii



Servis

- Livrare la domiciliu inclusa in pret
- Termen scurt de livrare
- Manual de asamblare cu imagini / 3D ilustratii pentru asamblare usoara
- Consultanta de la echipa de Service Biohort
- Servicii de asamblare disponibile la cerere



Siguranta

- Mecanism inchidere cu incuietoare cilindrica
- Ignifug

*Se aplica doar la case de gradina asamblate profesional si ancorate.

O companie cu istorie:

Inceputurile companiei Biohort

In anii 1970 am produs case de gradina in fabrica Normstahl in Niederwaldkirchen. Mai tarziu, in 1994, a fost fondata Biohort GmbH iar in 1997, Dr. Josef Priglinger a preluat in totalitate actiunile Biohort de la Normstahl's.

La sfarsitul mileniului Biohort era deja listat in cele mai multe magazine de constructii si DIY si era din ce in ce mai cunoscut in tarile vorbitoare de germana. De-a lungul anilor Biohort si-a castigat pozitia de leader de piata in Europa.

Dezvoltare continua a produsului

In primii ani am produs diferite case de gradina, compostoare din metal si jardiniere. Casa de gradina Europa a fost prezentata in 1996 si inca este un model clasic. Au urmat tot mai multe modele diferite, in aproape fiecare an Biohort surprinde cu o idee noua. Portfoliul actual il gasiti in acest catalog. Pe langa dezvoltarea produselor noi, ne imbunatim constant si ne extindem produsele existente. Inovatia si calitatea sunt prioritatile noastre!



Casa de gradina Europa la inceput

PENTRU
MAI MULTA
BUCURIE IN
GRADINA TA





10 Neo



12 HighLine®



14 Panorama®



16 AvantGarde® & AvantGarde®ECO



20 Europa



22 Equipment Locker



32 CasaNova®



Neo Marime 2B, Argintiu metalizat
(cu accesorii: rama de podea din aluminiu, panou podea din aluminiu si usa dubla)

Neo

Revolutie in Design & Functionalitate

Cel mai bun dupa zeci de ani de experienta - produsul Biohort de top

Suprafata neteda a peretilor si panoul elegant de sticla acrilica in usa caracterizeaza aspectul modern. Panouri de sticla aditionale pot fi fixate usor datorita sistemului de panouri special conceput. Pentru a asigura un ambient placut, tavanul din lemn regleaza umiditatea impreuna cu panourile optionale gri deschis si izolatia.



Argintiu
Metalizat

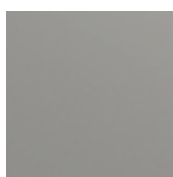

Gri quart
Metalizat



Gri Inchis
Metalizat



Marimea 2B, Gri inchis metalizat cu pergola.
Pereti laterali si un perete spate pe post de paravan sunt disponibili separat (vezi accesoriiile p.24).
Sfat: Panoul din sticla si FloraBoard sunt de asemenea disponibile pentru pergola.

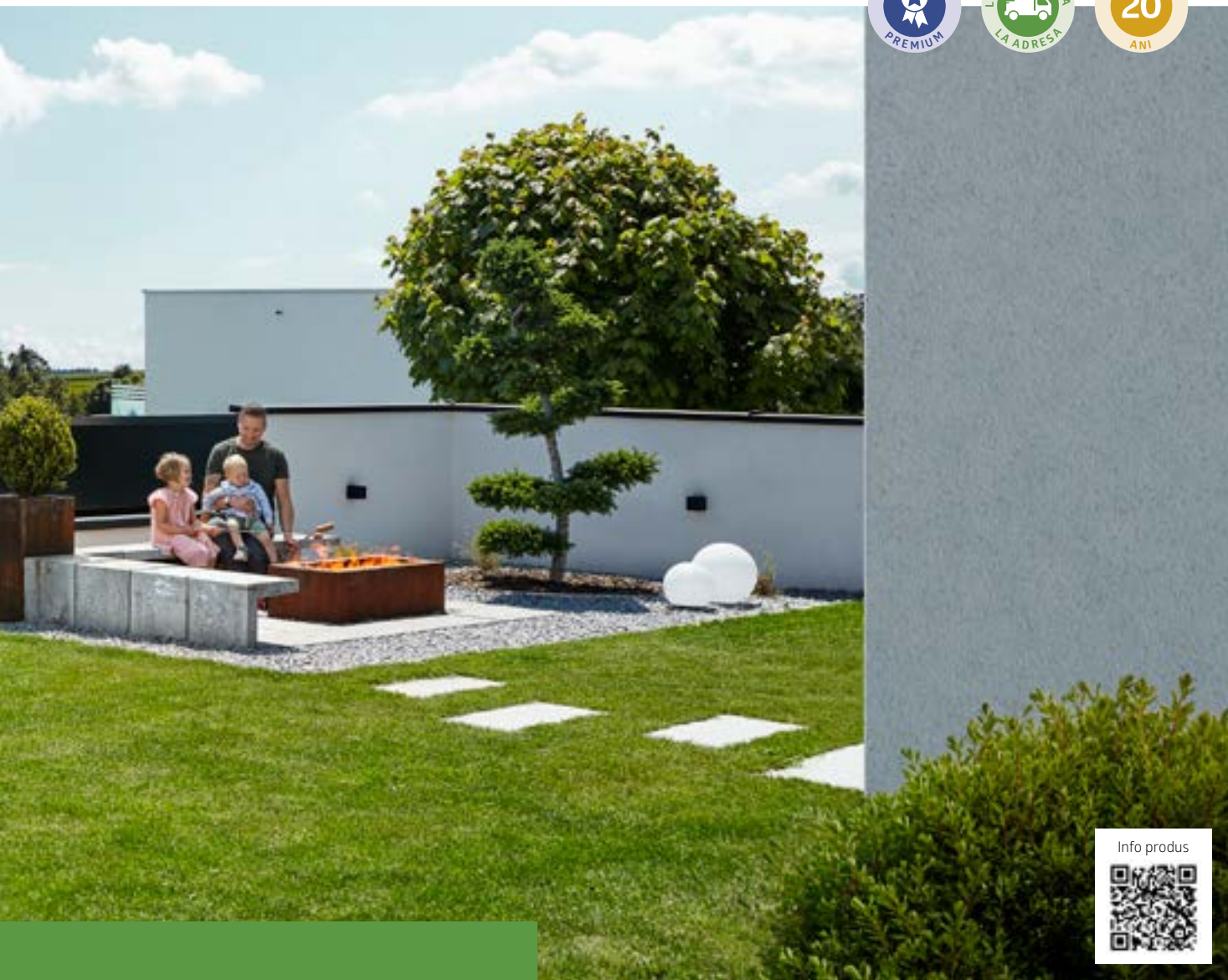

Avantaje

Siguranta:

- mecanism de inchidere in 3 puncte si clanta din otel inoxidabil
- Protectie la furtuna pana la o forta a vantului de 12 - 150 km/h
- Greutate mare a zapezii pana la 150 kg/m²
- Suprafete fara suruburi si nituri

Functionalitate:

- Deschidere usa confortabila cu arc cu amortizor pe gaz
- Panouri interioare si izolatie optional
- Jgheab integrat

Dotare standard:

- Sticla integrata la usa standard
- Tavan din lemn din furnir de 19 mm cu membrana EPDM 1,5 mm
- Set burlane (2 buc)
- Suport unelte (2 buc.)
- Agatatoare unelte (2 buc.)
- Rafturi (2 buc.)



Accesoriile optionale gasiti la paginile 22 - 31.

Marime (in cm, dimensiuni exterioare inclusiv limita acoperisului)

Deschidere usa:

Usa standard (balama pe dreapta): 83 x 200 cm (l x H) - usa standard se poate instala pe partile laterale ale casutei de gradina.

Usa Dubla: 167 x 200 cm (l x H) - usa dubla se poate instala pe partile de 236 cm ale casei.

Marcajele albastre pe jgheab indica partea la care poate fi atasata pergola optionala (incepand cu marimea 2A). Vezi pagina 24 pentru detalii.

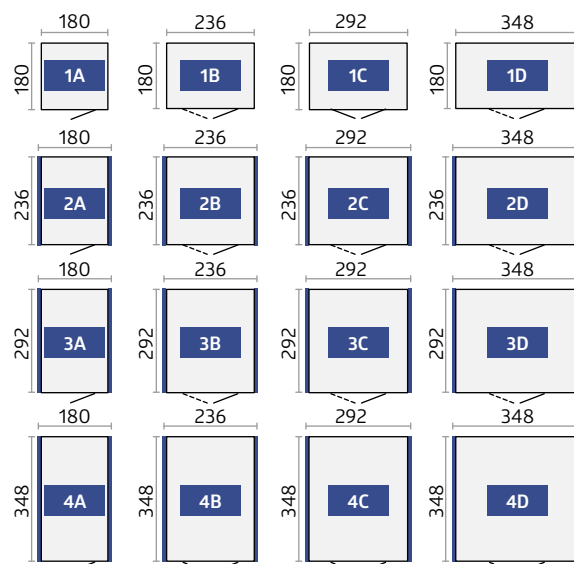

Date tehnice si informatii detaliate gasiti la paginile 84 - 85.



HighLine® Marime H2, Gri inchis metalizat
(cu accesorii: rama de podea din aluminiu, panou podea din aluminiu si usa dubla)

HighLine®

Un exemplu de
Design & Tehnologie

Casa de gradina HighLine® indeplineste cele mai inalte standarde

Design industrial sofisticat intr-o forma impresionanta: Acoperisul plat modern si luminatorul integrat, de jur imprejur, confera casutei HighLine® accente puternice. Sistemul de inchidere in 3 moduri cu o incuietoare cilindrica robusta asigura siguranta optima. Deschiderea si inchiderea usii este semi-automata cu ajutorul unui telescop pe gaz. Casa de gradina HighLine® nu necesita absolut nicio mentenanta!



Argintiu Metalizat



Gri cuart Metalizat

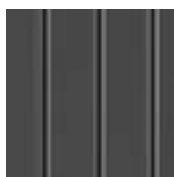

Gri Inchis Metalizat

(Suprafata acoperisului este intotdeauna gri cuart metalizat)



HighLine® Marimea H3, Argintiu metalizat cu acoperis lateral

Pereti laterali si un perete spate pe post de paravan sunt disponibili separat (vezi accesorii, p. 24).



Avantaje

Siguranta:

- mecanism de inchidere in 3 puncte si clanta din otel inoxidabil
- Protectie la furtuna pana la o forta a vantului de 12 - 150 km/h
- Greutate mare a zapezii pana la 150 kg/2

Functionalitate:

- Jgheab integrat cu conexiune de 1 1/4"
- Jgheab cu filtru integrat pentru frunze pe ambele parti
- Deschidere usa confortabila cu arc hidraulic

Dotare standard:

- Panou din acril 360°
- Suport unelte (2 buc.)
- Agatatoare unelte (4 buc.)
- Rafturi si sine suport (2 buc. din fiecare)

Marimile (in cm, dimensiuni exterioare inclusiv limita acoperisului)

Deschidere usa:

Usa standard (balama pe dreapta): 76 x 182 cm (l x H)

Usa Dubla: 155 x 182 cm (l x H)

Marcajele albastre pe jgheab indica locul in care poate fi atasat acoperisul lateral optional (incepand cu marimea H2). Vezi pagina 24 pentru detalii.

Liniile intrerupte marcheaza limita acoperisului.

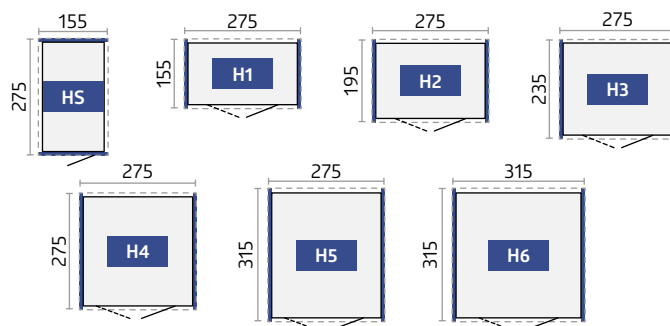

Sfat: Puteti roti HighLine®, incepand cu marimea H2, conform preferintelor, iar usa standard poate fi instalata in orice perete lateral

Incepand cu marimea H4 este posibila instalarea usii duble in peretele lateral.

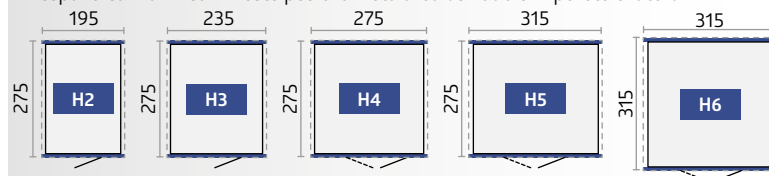

Date tehnice si informatii detaliate gasiti la paginile 86 - 88.



Accesorii optionale gasiti la paginile 22 - 31.



Panorama® Marime P2, Gri inchis metalizat
(cu accesorii: rama de podea din aluminiu, panou podea din aluminiu si Flora Board)

Panorama®

Iluminare Interioara

Frumusetea luminii naturale

Luminatorul din sticla acrilica confera casutei Panorama® un aspect luminos si permite acestui model cu acoperisul cu fronton sa se potriveasca natural in spatiul inconjurator. Calitatea dovedita a materialelor si a manoperei impreuna cu selectia accesoriiilor optionale individuale si varietatea de marimi disponibile fac din Panorama® casa de gradina perfecta care sa se potriveasca celor mai ridicate cerinte.



Argintiu
Metalizat



Gri cuart
Metalizat

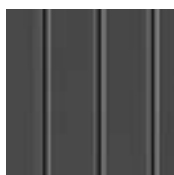

Gri Inchis
Metalizat



Marime P2, Gri cuart metalizat
Incepad cu marimea P2 usa standard se poate fixa pe orice perete lateral.

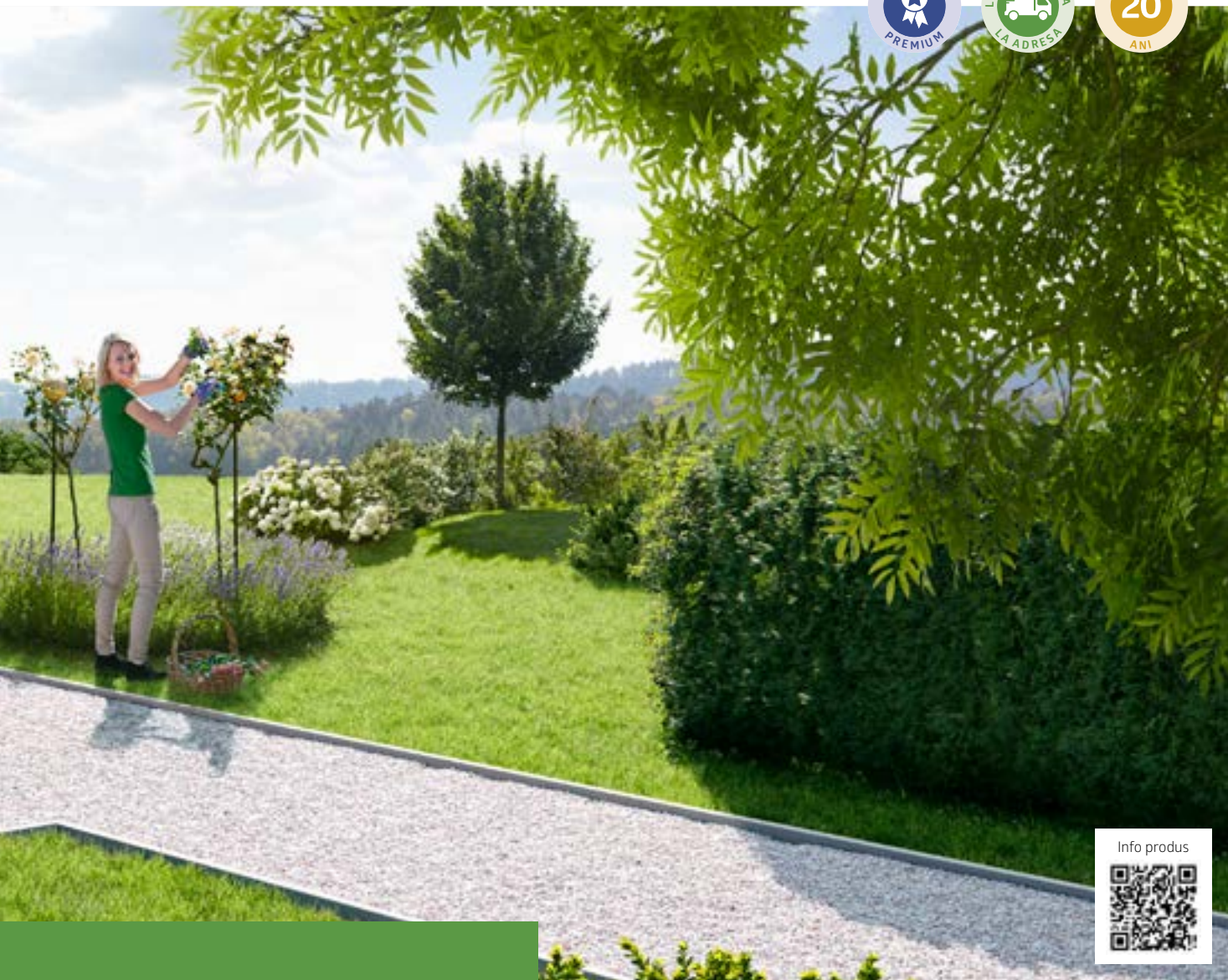

Avantaje

Siguranta:

- mecanism de inchidere in 3 puncte si clanta din otel inoxidabil
- Protectie la furtuna pana la o forta a vantului de 12 - 150 km/h
- Greutate mare a zapezii pana la 150 kg/m²

Functionalitate:

- Jgheab integrat cu conexiune de 1 1/4"
- Jgheab cu filtru integrat pentru frunze pe ambele parti
- Deschidere usa confortabila cu arc hidraulic

Dotare standard:

- Panou din acril 360°
- Suport unelte (2 buc.)
- Agatatoare unelte (4 buc.)
- Rafturi si sine suport (2 buc.din fiecare)

Marime (in cm, dimensiuni exterioare inclusiv limita acoperisului)

Deschidere usa:

Usa standard (balama pe dreapta): 76 x 182 cm (l x H) – de la marimea P2, usa standard se poate instala pe oricare perete lateral.

Usa Dubla: 155 x 182 cm (l x H) – de la marimea P4, usa dubla se poate instala pe oricare perete lateral

Liniile intrerupte marcheaza limita acoperisului.

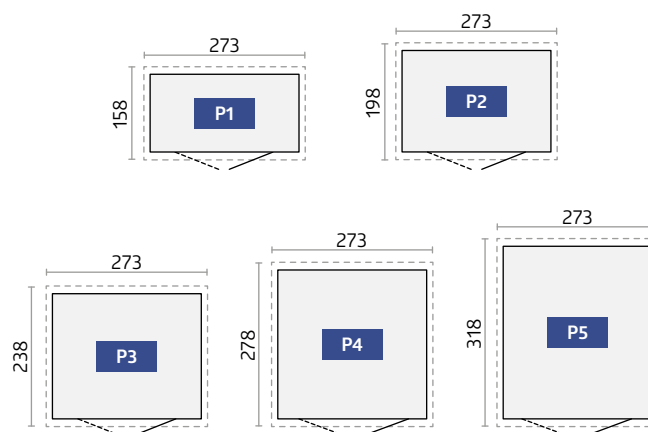

Accesorii optionale gasiti la paginile 22 – 31.

Date tehnice si informatii detaliate gasiti la paginile 86 – 88.



reddot design award



AvantGarde® Marime A5, Argintiu metalizat
(cu usa dubla neteda, rama de podea din aluminiu si panouri podea din aluminiu ca accesorii)

Info produs



AvantGarde®

Arhitectura moderna

Casa de gradina Top Quality

AvantGarde® isi confirma numele. Este o casa de gradina extrem de stabila care indeplineste cerintele arhitecturii moderne. Aspectul atractiv si numeroasele avantaje practice pe care le ofera in utilizarea zilnica garanteaza ca va veti bucura de ea. Nu necesita mentenanta deloc si astfel economisiti timp pretios si bani.



Argintiu Metalizat



Gri cuart Metalizat



Gri Inchis Metalizat



Marimea 3, gri inchis metalizat cu usa dubla Slim



AvantGarde® ECO

Versiunea ECO la un pret atractiv!



Marimea A5 in versiunea ECO, gri cuart metalizat cu usa standard cu striatii

Pentru clientii preocupati de pret, recomandam versiunea ECO cu usa cu striatii si incuietoare cilindrica in T.

Cu sistem de organizare integrat pe interiorul usii si carlig in loc de telescop pe gaz. **Versiunea ECO nu este echipata cu dotarile standard , ceea ce o face atractiva din punct de vedere al pretului.** Deschiderea usii si marimile sunt exact ca la AvantGarde®. De asemenea disponibil cu usa dubla cu striatii.



Avantaje

Siguranta:

- mecanism de inchidere in 3 puncte si clanta din otel inoxidabil / mecanism in 2 pozitii pentru versiunea ECO
- Protectie la furtuna pana la o forta a vantului de 12 - 150 km/h
- Greutate mare a zapezii pana la 150 kg/m²

Functionalitate:

- Jgheab integrat cu conexiune de 1 1/4"
- Luminator din acril sub acoperis

Dotare standard*:

- Suport unelte (2 buc.)
- Agatatoare unelte (4 buc.)
- Rafturi si sine suport (2 buc. din fiecare)
- Deschidere usa confortabila cu arc hidraulic

* nu este inclus la versiunea ECO

Marimile AvantGarde® si AvantGarde® ECO

(in cm, dimensiuni exterioare inclusiv limita acoperisului)

Deschidere usa:

Usa standard (balama pe dreapta): 76 x 182 cm (l x H)

Usa dubla A1 - A4: 139 x 182 cm (l x H)

Usa dubla A5 - A8: 155 x 182 cm (l x H)

Linile intrerupte marcheaza limita acoperisului.

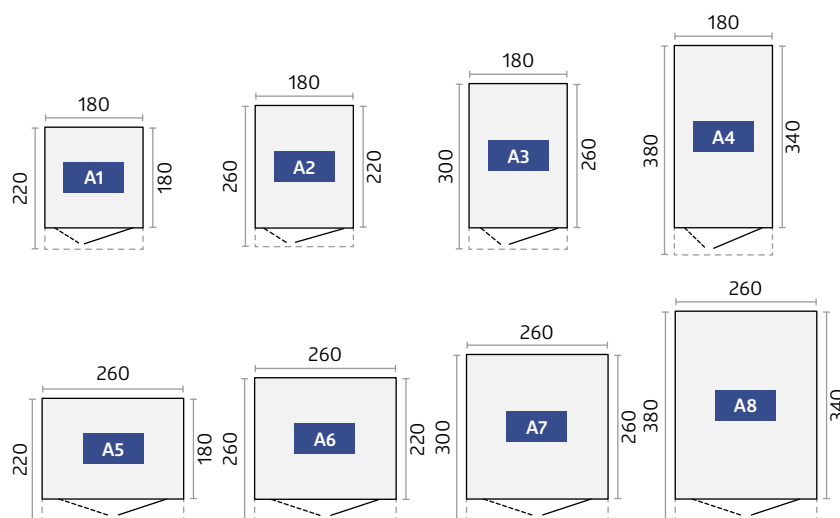

Accesorii optionale gasiti la paginile 22 - 31.

Date tehnice si informatii detaliate gasiti la paginile 86 - 88.



Europa marime 3, Gri quart metalizat
 (Cu rama fixare podea din aluminiu si podea din aluminiu ca accesorii)

Europa

Calitate la un Pret Corect

Totul bine organizat in acest model Biohort clasic

Testat si dovedit zeci de ani si inca foarte popular! S-au vandut mai mult de 150 000 unitati Europa si posesorii lor se bucura de ele cu mandrie. Stabilitatea foarte buna, materialele durabile si faptul ca nu necesita intretinere sunt motivele. Caracteristicile functionale iti simplifica munca si te ajuta sa mentii ordinea. O gama larga de dotari standard si accesorii sofisticate iti satisfac cerintele.



Argintiu Metalizat



Gri quart Metalizat



Gri Inchis Metalizat



Verde Inchis



Marimea 4, Gri inchis metalizat cu acoperis lateral
 (vezi accesoriile p. 24)

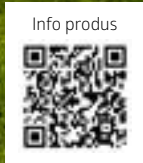

Avantaje

Siguranta:

- mecanism inchidere in 2 pozitii cu maner in T incuietore cilindrica
- Protectie la furtuna pana la o forta a vantului de 12 - 150 km/h
- Greutate mare a zapezii pana la 150 kg/m²

Functionalitate:

- Jgheab integrat cu conexiune de 1"

Dotare standard:

- Usa Dubla
- Sistem organizare in interiorul usii (include 6 carlige)
- Agatatoare unelte (4 buc.)
- Rafturi si sine suport (2 buc.din fiecare)
- Doi suporti fixare additionali pentru asamblare pereti (la marimea 2A si 4A)
- Carlig de usa pentru a sustine usa deschisa

Marime (in cm, dimensiuni exterioare inclusiv limita acoperisului)

Deschidere usa:

Usa Dubla: 135 x 170 cm (l x H) - de la marimea 2A este posibila fixarea in pozitie laterala a usii duble, pentru marimile 2, 3, 4, 5, 6 si 7 este posibila instalarea usii duble pe peretii laterali.

Linile intrerupte marcheaza limita acoperisului.

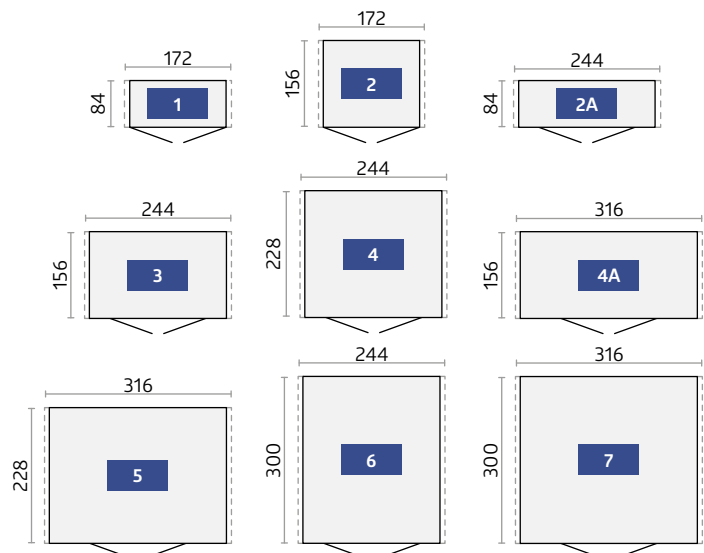

Accesorii optionale gasiti la paginile 22 - 31.

Date tehnice si informatii detaliate gasiti la paginile 88 - 89.



Equipment Locker, Marime 230, Gri quart metalizat
(Cu rama fixare podea din aluminiu si podea din aluminiu ca accesorii)

Equipment Locker

Mic dar Versatil

Un dulap atractiv si foarte versatil

Cand nu ai spatiu Equipment Locker isi arata valoarea. In gradina, pe terasa, in garaj sau pe balcon iti permite sa iti organizezi spatiul si sa iti depozitezi uneltele fara sa-ti micsozezi spatiul propriu. In Equipment Locker de la Biohort poti sa-ti protejezi echipamentul de gradina, gratarul, mobilierul de gradina si alte obiecte similare, de ploaie si de furt. Se integreaza armonios in locatia sa datorita celor sapte marimi diferite si a designului elegant.



Argintiu Metalizat



Gri quart Metalizat

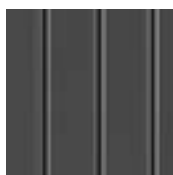

Gri Inchis Metalizat



Marimea 90, gri inchis metalizat cu rama de podea din aluminiu si panouri de podea ca accesorii.

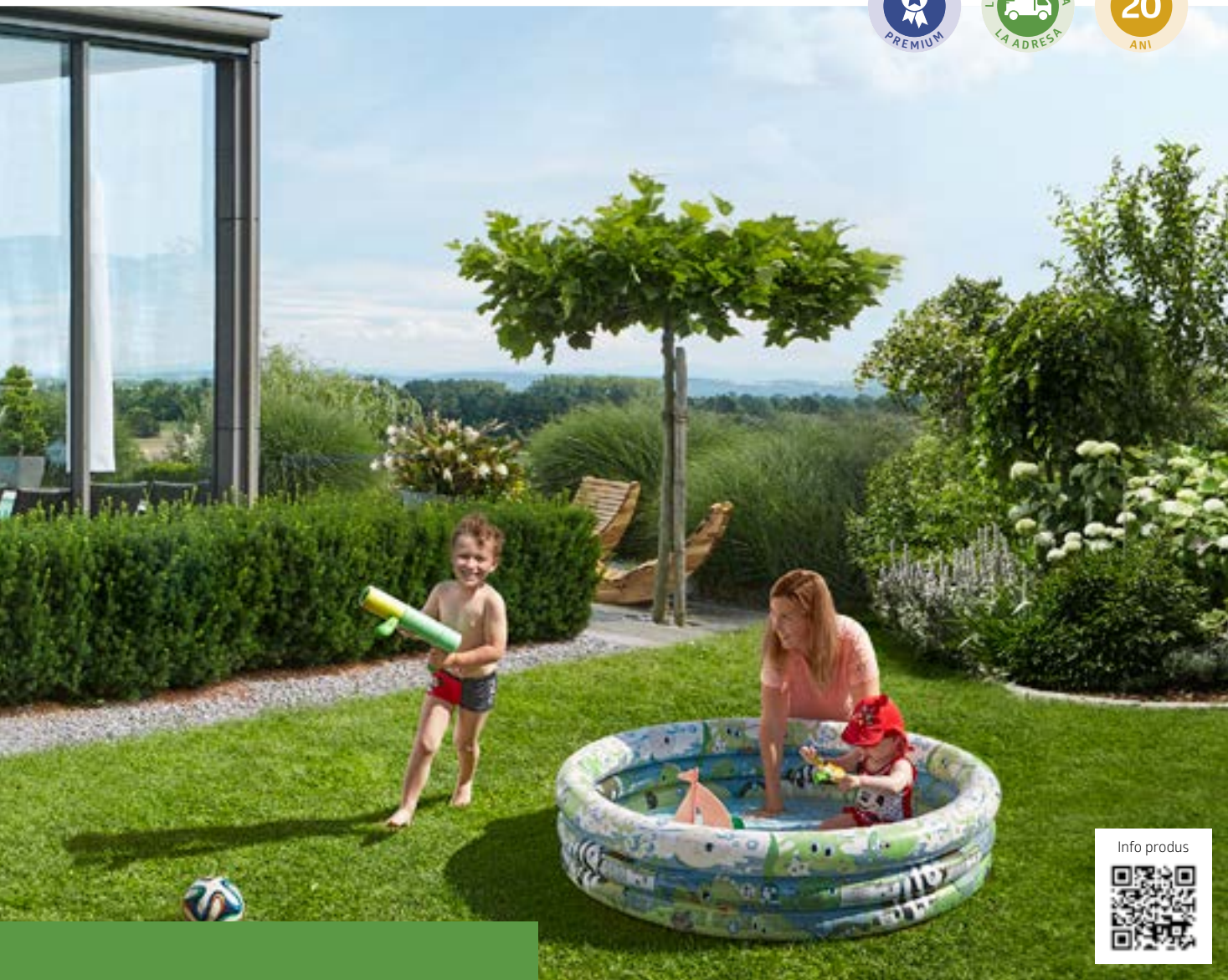

Avantaje

- Sistem ventilatie integrat invizibil
- Etans impotriva apei de ploaie

Siguranta:

- mecanism inchidere in 2 pozitii cu maner in T incuietoare cilindrica
- Ignifug

Dotare standard:

- Usa dubla (de la marimea 150)
- Sistem organizare in interiorul usii (include 6 carlige)
- Agatatoare unelte (4 buc.)
- Rafturi si sine suport (2 buc. din fiecare)
- Carlig de usa pentru a sustine usa deschisa

Marimi (in cm, dimensiuni exterioare)

Deschidere usa:

Marime 90: 65 x 170 cm (l x H), marime 150 - 230: 135 x 170 cm (l x H)



Marimi cu adancime dubla (in cm, dimensiuni exterioare)

Deschidere usa:

135 x 170 cm (l x H)

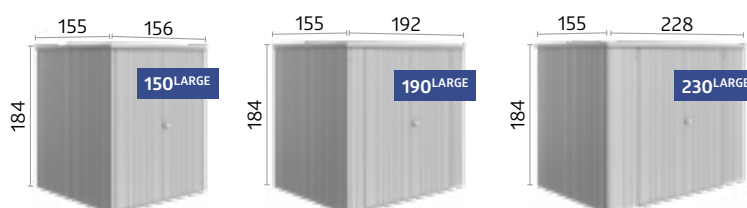







































































































Accesorii optionale gasiti la paginile 22 - 31.

Date tehnice si informatii detaliate gasiti la paginile 88 - 89.

 **Echipament standard**

 **Accesorii optionale disponibile**

	Neo**	HighLine®	Panorama®	AvantGarde®	AvantGarde®ECO	Europa	Equipment Locker
01 Sine suport Pentru accesoriile care se monteaza precum rafturi,cosuri, set carlige, cosuri suspendate si masa plianta. Echipament standard: Include 2 sine suport. (Exceptie Casa de gradina Neo: nu sunt necesare sine suport, Casa de gradina AvantGarde®ECO: nu are dotari standard)		 	 	 		 	 
02 Rafturi Rafturile cu adancime 24,5 cm sau 43,5 cm sunt suspendate pe doua sine suport*. (2 bucati per pachet) (Exceptie casa de gradina Neo: rafturi de 26 cm sau 44,5 cm adancime.) Greutatea pe care o suporta 15 kg per raft Dotare standard: 2 rafturi (Exceptie Casa de gradina AvantGarde®ECO: nu are dotari standard)	 	 	 	 		 	 
03 Agatatoare unelte Pentru a agata sapa, grebla, furtunul si alte unelte de gradina. (Greutatea pe care o suporta: 10 kg). Dotare standard: 4 agatatori unelte (Exceptie casa de gradina Neo: 2 bucati Casa de gradina AvantGarde®ECO: nu are dotari standard)	 	 	 	 		 	 
04 Suport Unelte Pentru a fi montat in interiorul usii. Maxim 4 suporti unelte pot si montati pe usa. Echipament standard: 2 suporti unelte (Exceptie Casa de gradina AvantGarde®ECO: nu are dotari standard)	 	 	 	 			
05 Cosuri metalice pe usa Cosurile pentru usa se monteaza usor in interiorul usii. Ideal pentru depozitarea uneltelor de gradina, a manusilor etc, la indemana (2 bucati per pachet) Dimensiuni (l x L x H) 37 x 10 x 9,5 cm, greutatea pe care o suporta : 1 kg per cos							
06 Etajere cu cosuri metalice Etajere cu cosuri metalice sunt sustinute de 2 sine suport*. Ideal pentru depozitarea pesticidelor, a semintelor, a cutiilor de tabla si a uneltelor. (2 bucati per pachet). Dimensiuni (l x L x H) 72 x 16 x 11 cm, greutatea pe care o suporta : 3 kg per cos							
07 Set carlige Consta dintr-o combinatie de carlige, un carlig pentru maner si un carlig pentru sapa pe un suport agatat de 2 sine suport*.							
08 Cos Suspendat Ideal pentru depozitarea obiectelor mici, include suporti de prindere de cele 2 sine suport*. Sac din plasa de poliester negru. Dimensiuni (l x L x H) 67 x 34 x 20 cm (exceptie modelul Neo: 55 x 34 x 20 cm)							
09 Masa plianta Masa plianta care te ajuta sa economisesti spatiu este agatata de 2 sine suport*. Iti pune la dispozitie rapid o suprafata de lucru stabila. Greutatea pe care o poate sustine max. 30 kg,marime (l x L): 69 x 58 cm.							
10 Panou montaj electric Pozitionarea usoara si discreta a cablurilor,asamblare usoara a intreruptoarelor si prizelor (echipamentul din poza nu este inclus).							
11 Lampa LED Lampa pe baterie cu senzor de miscare sau intreruptor, fixare magnetica, inclusiv cablu incarcare USB.							
12 Set burlane Doua burlane in aceiasi culoare ca si casa de gradina.							
13 Panouri Interioare Panourile de perete interior gri deschis sunt fixate in peretii laterali cu suruburi.							
14 Izolatie Panourile de interior se pot izola cu panouri de polistiren de 40mm, conferind casutei de gradina multe alte posibilitati de intrebuintare.							

*Sinele suport nu sunt incluse in livrare (Exceptie modelul Neo : nu sunt necesare sine suport).

**Atentie: Modelul Neo nu are panourile cu striatii, acest lucru nu a fost luat in considerare in ilustratie.

Date tehnice si informatii detaliate gasiti la paginile 84 – 89.



01 Sine suport
02 Rafturi



03 Agatatoare unelte



04 Suport unelte



05 Cosuri metalice pe usa



07 Set carlige



08 Cos suspendat



06 Etajere cu cosuri metalice



09 Masa plianta



10 Panou montaj electric



11 Lampa LED



12 Set burlane



































13 Panouri inetrioare pentru modelul Neo



14 Izolatie pentru modelul Neo (invizibila)

 **Dotare standard**

 **Accesorii optionale disponibile**

	Neo	HighLine®	Panorama®	AvantGarde®	AvantGarde®ECO	Europa	Equipment Locker
<p>15 FloraBoard Doua sine de aceeasi culoare sunt atasate pe peretii exteriori si pe ei se agata jardinierele la inaltimea potrivita. Despartitoare de plastic pentru a usura plantarea sunt incluse ca dotare standard. Sfat: La modelul Neo, FloraBoard este disponibil pe peretele din spate sau lateral al acoperisului lateral.</p>							
<p>16 Fereastră Peretele lateral cu fereasta cu rama de metal (plexiglass) aduce mai multa lumina si ofera o priveliste asupra gradinii (dimensiuni fereasta: 50 x 60 cm).</p>							
<p>17 Panou sticla pentru modelul Neo Panoul de sticla este incadrat intr-o rama de metal (Dimensiuni: 28 x 207 cm) si se poate instala pe orice perete lateral, dar nu langa usa, langa colt sau langa un alt panou de sticla. Sfat: Panoul de sticla este disponibil pentru variantele cu acoperisul lateral si peretele din spate sau lateral.</p>							
<p>18 Arc cu amortizor pe gaz Asigura o deschidere confortabila a usii. Echipament standard: 2 bucati (cu exceptia modeleor AvantGarde®ECO, Europa and Equipment Locker). De asemenea este disponibil si ca accesoriu optional pentru modelul AvantGarde®ECO.</p>							
<p>19 Usa Dubla Iti este mai usor sa intri sau sa iesi cu unelte mari. Usa dubla este dotata pe interior cu o incuietoare rotativa si cu un amortizor pe gaz (Exceptie: Modelele AvantGarde®ECO, Europa si Equipment Locker). Modelul Neo: sticla in panoul usii pe dreapta. (Exceptie Equipment Locker size 90).</p>							
<p>20 Usa aditionala In pachetul standard aveti clanta din otel inoxidabil cu cilindru, un sistem de inchidere in 3 puncte, un arc cu amortizor pe gaz, doua suporturi pentru unelte si fittingurile din metal necesare pentru pozitionarea balamalelor. Usa are balamalele pe dreapta* si la cerere pot fi si pe stanga. Modelul Neo: standard cu panou de sticla in usa.</p> <p>Modelul AvantGarde®ECO: Usa este disponibila si in versiunea cu cost redus ECO, o suprafata cu striatii, cu maner in T, cu inchidere in 2 puncte, carlige pe usa, balamale si sistem de organizare pe interiorul usii</p> <p>Modelul Europa : usa dubla, suprafata cu striatii, cu incuietoare cilindrica in T, 2 puncte de inchidere, carlige la usa si sistem de organizare pe interiorul usii.</p>							
<p>21 Pergola Pergola poate fi atasata la modelul Neo (incepand cu marimea 2A) pe oricare dintre laturi. latimea pergolei este 300 cm. Suportii din aluminiu sunt dotati cu picioare ajustabile. Sunt incluse doua burlane.</p> <p>Pergola laterala se fixeaza de HighLine® (de la marimea H2) pe partea cu jgheabul (optional pe o parte sau pe ambele). Este disponibil in doua marimi diferite. Latimea pergolei marimea S este 150 cm si pentru marimea L 282. Suportii din aluminiu sunt dotati cu picioare ajustabile. Burlanele sunt incluse.</p> <p>Pergola laterala la modelul Europa se poate atasa fie pe stanga ,fie pe dreapta sau pe ambele parti. Setul include suportii, un burlan scurt si materialele pentru fixare (nu este disponibil pentru marimile 1 si 2A).</p>							
<p>22 Pergola cu perete lateral si perete spate Poti atasat un perete spate si/sau un perete lateral la pergola modelului tau HighLine® (incepand cu marimea H2) / Neo (de la marimea 2A). Sunt disponibile in aceleasi culori ca si casa de gradina.</p>							

*Exceptie modelul Neo: Balamaua este disponibila doar pe dreapta.



15 FloraBoard



16 Fereasta



17 Panou sticla pentru modelul Neo



18 Arc cu amortizor pe gaz



19 Usa dubla/20 Usa aditionala



21 Pergola laterala pentru modelul Neo



21 Pergola laterala pentru modelul HighLine® / Europa



22 Pergola spate si lateral pentru modelul Highline®



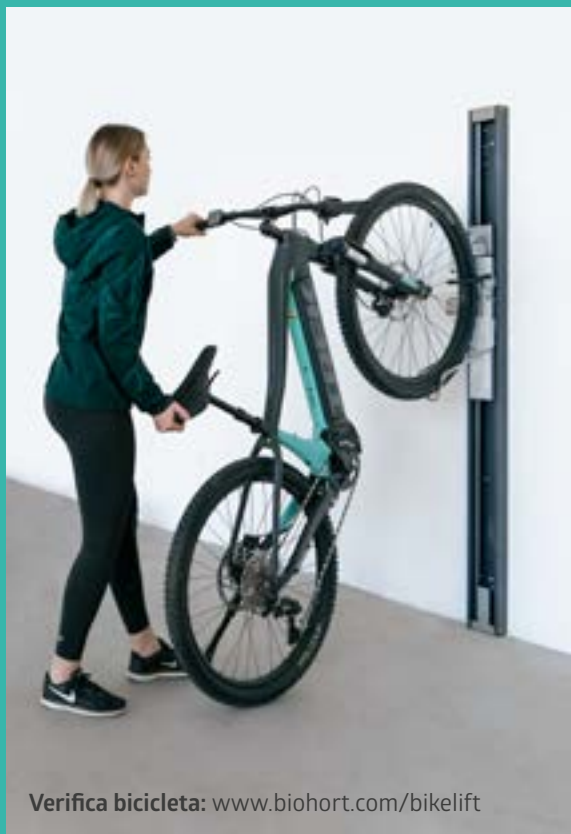

22 Pergola cu perete lateral si perete spate pentru modelul Neo



Verifica bicicleta: www.biohort.com/bikelift

Avantajele sistemului BikeLift®

-  bicicleta se poate incuia
-  functioneaza la biciclete de pana la 30 kg
-  potrivit pentru cauciucuri cu latimea pana in 77mm/3 inch

BikeLift® de la Biohort poate fi montat pe peretele pivnitei, in garaj sau in carport in cativa pasi simpli. Este chiar si mai usor sa il montezi intr-o casa de gradina - BikeLift® se agata acolo ca accesoriu optional

Acest sistem inovativ este disponibil in doua variante:
Standard sau cu pivot

Un sistem de ridicare usor pentru orice bicicleta

De la e-mountain bike la biciclete de viteza BikeLift® de la Biohort iti ridica extrem de usor bicicleta pe perete vertical, ca si cum ar urca singura. Faci economie de spatiu fara efort.



Agati

Pur si simplu agati roata din fata in BikeLift®. Agatatoarea se potriveste la orice cauciuc pana la 77 mm.



Impinge

Impingi in jos scurt ghidonul pentru a activa functia de ridicare.



Ridicare

Datorita arcurilor puternice BikeLift® trage orice bicicleta de pana la 30 kg ca si cum s-ar ridica singura.



Economisesti spatiu

Bicicleta sta vertical pe perete, in siguranta si incuiata si economisesti si spatiu.

★ Accesorii optionale disponibile

	Neo**	HighLine®	Panorama®	AvantGarde®	AvantGarde®ECO	Europa	Equipment Locker
23 BikeLift® Standard Sistemul bike lift se prinde in profilele peretilor si este potrivit pentru biciclete cu diametrul exterior al cauciucurilor de pana la 29 inch, latimea cauciucului max. 77 mm, inaltimea totala a rotii inclusiv cauciucul 77 mm, lungime bicicleta 1,95m si greutate maxima 30 kg. Aparatoarea de noroi si portbagajul nu trebuie sa depaseasca cauciucul. Lacasul pentru incuietoarea bicicletei este integrat.	★	★	★	★	★	★	
24 BikeLift® cu pivot Ca sa economisesti mai mult spatiu, bicicleta poate fi pozitionala paralel cu peretele datorita acestui dispozitiv. In casa Europa, BikeLift® cu suport pivotant se poate asambla doar central pe peretele din spate.	★	★	★	★	★	★	
25 Prag cu rampa acces Pentru interior si exterior, pentru trecerea usoara a pragului, disponibil doar impreuna cu rama de fixare din aluminiu si usa dubla. Suporta o incarcatura de max. 200 kg, lungime: 135cm (exceptie modelul Neo: 163,5 cm).	★	★	★	★	★	★	
26 Sistem agatat bicicleta BikeMax Modelul Europa : inaltime ajustabila in 6 pozitii diferite, pentru biciclete de pana la 26 de inch, cu o grosime a cauciucului de max, 5cm si o greutate max de 25 kg. Modelele Neo, HighLine®, Panorama®, AvantGarde® si AvantGarde®ECO: inaltime ajustabila in 8 pozitii diferite si potrivite pentru biciclete cu roti pana la 29". Lacasul pentru incuietoarea bicicletei este integrat.	★	★	★	★	★	★	
27 Sistem fixare rastel Bicicleta BikeHolder O depozitare optima a bicicletei datorita sistemului de fixare ajustabil. Placa se prinde usor in cele 2 sine suport*. Fixare rapida si usoara a rotilor pentru maxim 3 biciclete cu sistemul BikeHolder.	★	★	★	★	★	★	

*Sinele suport nu sunt incluse (exceptie modelul Neo: nu sunt necesare sine suport.)

**Atentie: Modelul Neo nu are panourile ondulate, acest lucru nu a fost luat in considerare in ilustratie.



23 BikeLift® Standard



24 BikeLift® cu pivot



25 Prag cu rampa acces



26 Sistem agatat bicicleta BikeMax



27 Sistem fixare rastel Bicicleta BikeHolder

Date tehnice si informatii detaliate gasiti la paginile 84 - 89.

Solutii conventionale pentru fundatie

Mai multe informatii la :
www.biohort.com/fundatie

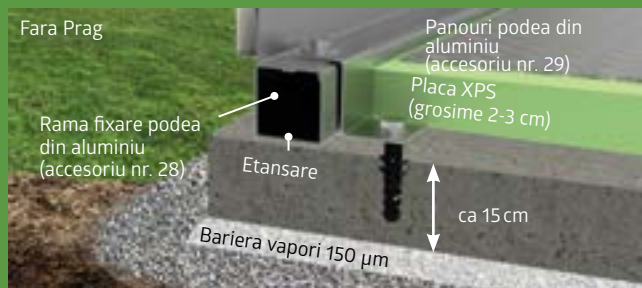

Fundatie din beton

O fundatie din beton pe o baza de pietris este o solutie optima dar scumpa. Cu acest tip de fundatie trebuie sa va asigurati ca apa nu patrunde in casuta la nivelul solului. O fundatie mai mare de 2 cm x 7 cm pe toata circumferinta este ideala (nu se pot folosi rama de fixare podea si panourile de podea din aluminiu).

Ca alternativa la fundatia in trepte, din beton, puteti turna o fundatie neteda din beton. Rama **de fixare podea din aluminiu**, disponibila ca accesoriu ajuta la compensarea micilor denivelari. Rama de fixare podea din aluminiu permite folosirea **panourilor de podea din aluminiu** si a unui strat de polistiren rigid XPS (nu este inclus in pachet).

Fundatie local doar pe punctele de fixare



O alta optiune de montaj a casei pe un teren denivelat este o fundatie locala impreuna cu **rama de podea din aluminiu**.

Pavaj



O solutie buna si nu costisitoare este pavajul pe o baza de pietris. Recomandam **rama de fixare podea din aluminiu**.

Rama podea

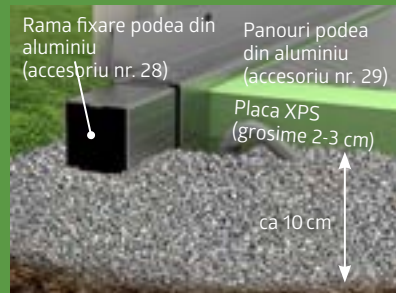

Cu **rama fixare podea**, puteti ancora casa de gradina pe o baza de pietris (suruburile de ancorare sunt disponibile ca accesorii). Panourile **de podea din aluminiu** au rol functional de podea si sub ele puteti pune un strat de polistiren (nu este inclus in pachet).

Solutii Smartbase Biohort

Informatii detaliate cu privire la SmartBase si SmartBase^{PLUS} gasiti la paginile 29 – 31.



★ Accesorii optionale disponibile

		Neo	HighLine®	Panorama®	AvantGarde®	AvantGarde®ECO	Europa	Equipment Locker
28	<p>Rama podea din aluminiu</p> <p>Confera casutei stabilitatea necesara chiar si fara o fundatie de beton. Daca rama de podea este asezata direct pe o baza de pietris (aprox. 10 cm de pietris fara fundatie sau dale), sunt necesare suruburile de ancorare pentru fixarea in sol. Acestea sunt disponibile ca accesorii-va rog sa vedeti datele tehnice pentru numarul de suruburi de ancorare. Rezistenta la vant puternic trebuie asigurata de catre client pentru acest tip de fundatie.</p>	★	★	★	★	★	★	★
29	<p>Panou podea din aluminiu</p> <p>In functie de marimea casei, podeaua de aluminiu consta din mai multe panouri inclusiv profilele de legatura. Pentru a asigura o asamblare optima este necesara rama de fixare a podelei (vezi mai sus). Este recomandata folosirea polistirenului de 2-3 cm sub panourile de podea (nu este inclus in pachet).</p>	★	★	★	★	★	★	★
30	<p>SmartBase</p> <p>Podeaua perfecta pentru o baza solida (beton sau pavaj). Astfel denivelarile usoare de pana la 40 mm pot fi compensate. Vezi detalii la pagina urmatoare.</p>	★	★	★	★	★	★	★
31	<p>SmartBase^{PLUS}</p> <p>O solutie optima pentru pante sau gradini, un sistem patentat cu suruburi care compenseaza pante pana la 15 cm. Vezi detalii pe pagina urmatoare.</p>	★	★	★	★	★	★	★



28 Rama podea din aluminiu



30 SmartBase
Vezi detalii la pagina urmatoare.



29 Panou podea din aluminiu



31 SmartBase^{PLUS}
Vezi detalii la pagina urmatoare.





Picioare ajustabile



Ajustare a inaltimii cu picioare reglabile



bariera impotriva apei de ploaie

SmartBase

Perfect pentru suprafete tari

Fundatia SmartBase de la Biohort este fundatia ideala pentru zone cu pavaj sau beton. Consta in placi de aluminiu de inalta calitate, o rama peciala pentru baza si picioare de ajutorare. Astfel denivelarile solului pana la 4 cm pot fi compensate.

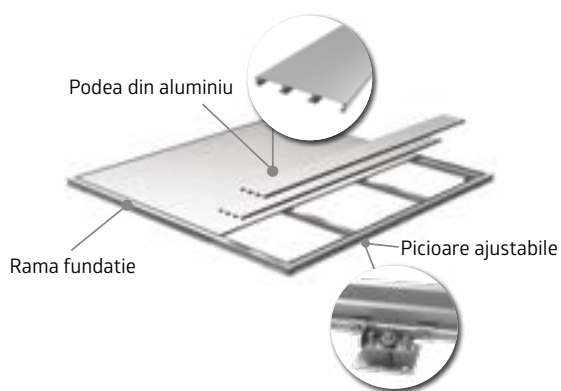

Tim necesar pentru asamblare: 1-2 ore pentru doua persoane (in functie de indemanare si produs) **Unelte necesare:** boloboc, bormasina, cheie de 13 si 24.

1. Asamblarea ramei
2. Legatura dintre picioarele reglabile si aliniamentul ramei
3. Fixarea picioarelor reglabile in suprafata
4. Fixarea panourilor podea

Avantaje

- Compensare a denivelarii cu ajutorul picioarelor reglabile
- Usor de indepartat daca este necesar
- Se potriveste la toate casele de gradina Biohort, la Equipment Locker si MiniGarage
- Rezistent la furtuna
- Suporta o incarcatura max. 200 kg/m²

Dotare standard:

- Panouri de aluminiu cu suprafata striata
- Rama proiectata special pentru fundatie
- Picioare reglabile galvaizate
- Picioare reglabile pe inaltime
- Protectie impotriva infiltrarii apei integrata

Rama de fixare si panourile de podea nu mai sunt necesare!

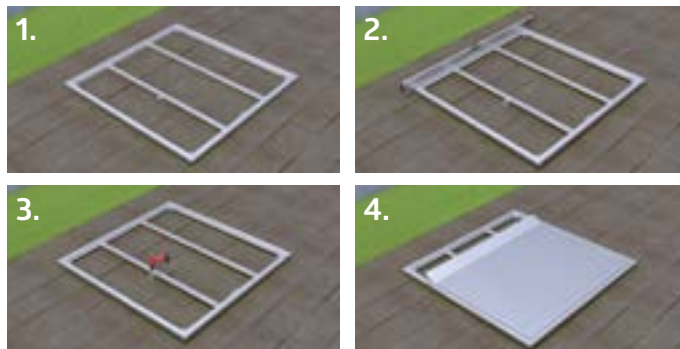



SmartBasePLUS

Solutii optime pentru pante si peluza

Spre deosebire de fundatia SmartBase, sistemul patentat SmartBase^{PLUS} include suruburi de fixare in loc de picioare reglabile. Acestea se insurubeaza direct in sol si pot compensa denivelari de pana la 15 cm (la cerere exista si variante pentru denivelari mai mari). Solul trebuie sa fie compact si sa nu contina pietre.

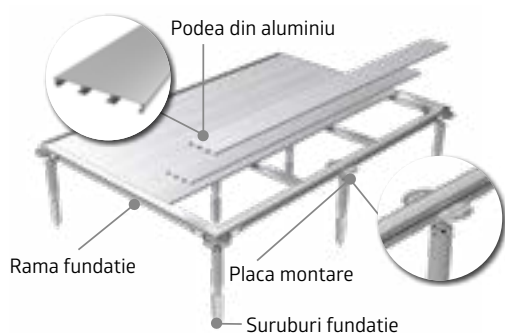

Timp necesar pentru asamblare: 2 - 4 ore pentru doua persoane (in functie de indemanare si produs). **Unelte necesare:** bormasina, bit Ø 40 x 570 mm, boloboc, drill, cheie de 13 si 24, lopata.

1. Pregatirea locului si fixarea cu suruburi de fundatie
2. Atasarea si nivelarea placilor de montaj
3. Pozitionarea si asamblarea ramei
4. Fixarea panourilor podea

Avantaje

- Doar o groapa mica
- Baza din pietris nu este necesara
- Compenseaza denivelarile prin suruburile de fixare
- Usor de indepartat daca este necesar
- Se potriveste la toate casele de gradina Biohort, la Equipment Locker si MiniGarage
- Rezistent la furtuna
- Suporta o incarcatura max. 200 kg/m²

Dotare standard:

- Panouri de aluminiu cu suprafata striata
- Rama proiectata special pentru fundatie
- Suruburi de fixare fundatie galvanizate
- Placi de fixare ajustabile in mai multe pozitii
- Surubelnita manuala inclusa
- Protectie impotriva infiltrarii apei integrata

Rama de fixare si panourile de podea nu mai sunt necesare!





Elemente de sticla optional

CasaNova® 3x5, Gri quart metalizat
(cu accesorii : rama de podea, luminator exterior, doua elemente de sticla si usa dubla)

CasaNova®

Design customizat
conform cerintelor
tale

Constructia din metal cu peretii laterali izolati

Fie ca e folosita ca magazie de gradina, atelier, sauna -modelul cu izolatia CasaNova® are o flexibilitate unica cu o gama variata de dotari optionale si se adapteaza exact ideilor tale. Indiferent daca iti doresti un loc in care sa-ti depozitezi plantele iarna sau vrei sa -ti faci o oaza de liniste in gradina: cu CasaNova® visele tale devin realitate la un nivel de calitate unic.



Gri quart
Metalizat



Gri Inchis
Metalizat



Pereti laterali izolati / Panou usa
Element sandwich cu polistiren de 40mm
(EPS W20)



..... Usa dubla de sticla optional

Avantaje

- Element sandwich cu mijlocul din polistiren de 40 mm (EPS W20)
- Suprafete fara suruburi si nituri

Siguranta:

- Mecanism de inchidere cu clanta din otel inoxidabil
- Acoperisul suporta pana la 215 kg/m² zapada

Functionalitate:

- Usor de incalzit datorita izolatiei; Valoarea U a peretilor laterali : 0,76 W/(m²K)
- Balamale pe dreapta sau pe stanga
- O gama larga de accesorii
- Aerisire prin panourile de sticla acrilica rabatabile
- Deschidere usa confortabila cu arc hidraulic

Info produs



Brosura CasaNova®
cerere prin:
www.biohort.com



9 marimi, 2 culori si posibilitati nenumarate

Dimensiuni de la 3x2m la 4x6m

Datorita sistemului modular dorintele voastre pot fi nelimitate. Paravanul si spalierul se pot pozitiona asa cum doriti

Configureaza-ti CasaNova® acum!
www.biohort.com/configurator

Detalii practice si multe posibilitati de aplicare



SPA si Wellness

CasaNova® 3x4, gri inchis metalizat, rama podea din aluminiu, 2 elemente de sticla, lumina exterioara si sauna ca accesorii



Masina si atelier

CasaNova® 3x5, gri inchis metalizat cu usa de garaj, cu usa aditionala si fereasta cu deschidere dubla ca accesorii



Hobby si sport

CasaNova® 3x4, gri inchis metalizat cu rama podea din aluminiu, podea din aluminiu, usa dubla, lumina exterioara si doua elemente de sticla ca accesorii



Biroul de acasa si loc de relaxare

CasaNova® 3x4, gri inchis metalizat cu rama podea, 2 elemente de sticla si lumina exterioara ca accesorii



ESTE VORBA DE STIL



36 Romeo®



38 StoreMax®



40 HighBoard



42 LoungeBox®



44 StyleBox®



46 LeisureTime Box



Dulap gradinaRomeo® Marime M, Gri
cuart metalizat

Romeo®

Dulap Gradina

Mai mult spatiu pentru lucrurile esentiale

Dulapul de gradina Romeo® creaza spatiu aditional fara sa aiba el nevoie de mult spatiu. Mai mult, te rasfata pe balcon sau in gradina cu o gama practica de rafturi, usi care se inchid incet datorita arcurilor cu amortizor si multe alte detalii tipice produselor Biohort!

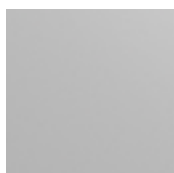

Argintiu
Metalizat

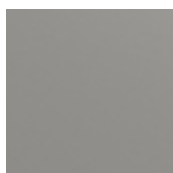

Gri quart
Metalizat

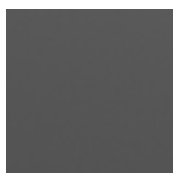

Gri Inchis
Metalizat



Marime L, Gri inchis metalizat



Avantaje

- Etans impotriva apei de ploaie
- Sistem ventilatie integrat invizibil

Siguranta:

- mecanism inchidere in 3 pozitii cu maner in T incuietore cilindrica

Functionalitate:

- Deschidere usa confortabila cu arc hidraulic

Dotare standard:

- Rafturi (2 buc) si sine suport (3 buc.)
- Sistem organizare in interiorul usii (include 6 carlige)

Info produs



Marime (in cm)

Deschidere usa:

103 x 131cm (l x H)

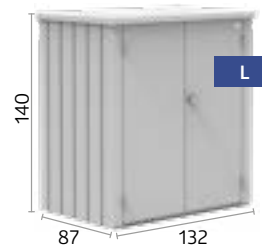
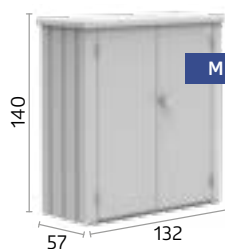

★ Accesorii optionale disponibile



Rafturi (2 bucati)

Rafturi din otel galvanizat (61 x 43 cm) disponibile additional celor care sunt in dotarea standard.



StoreMax® Marime 120, Gri quart metalizat

StoreMax®

Design la exterior,
spatiu la interior

Bucuria gradinii la cel mai inalt nivel

O gradina este o oaza de relaxare- cel putin daca este ordonata. De aceea StoreMax® ofera maximum de spatiu de depozitare intr-un spatiu mic, care poate fi organizat individual cu rafturi si etajere. Fie ca il folositi ca garaj pentru masina de tuns iarba, ca dulap sa va depozitati uneltele sau sa va tineti pernele de terasa, in spatele sistemului dublu de inchidere este loc pentru orice!



Argintiu Metalizat



Gri quart Metalizat

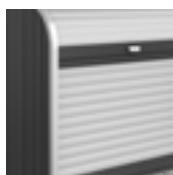

Gri Inchis Metalizat



Usile rulante din partea de sus se pot deschide separat.



Pentru a deschide complet StoreMax® partea din fata culiseaza complet in spate.



Avantaje

- Etans impotriva apei de ploaie
- Usi rulante din aluminiu

Siguranta:

- mecanism inchidere in 2 pozitii cu maner in T incuietoare cilindrica

Functionalitate:

- O operatie usoara datorita sistemului cu arc

Dotare standard:

- Suport unelte pe interiorul peretilor laterali

Info produs



Marime (in cm)

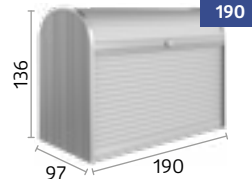
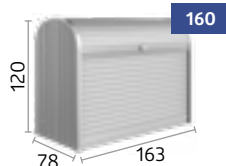
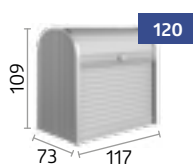

★ Accesorii optionale disponibile



Set rafturi pe colt (potrivit pentru marimile 120 & 160)

2 rafturi (triunghiulare) cu sine suport, inaltime ajustabila in 5 pozitii diferite, usor de modificat, se poate monta in stanga sau in dreapta, cum doriti.



Set rafturi (potrivit pentru marimea 190)

2 rafturi de otel (72 x 24,5 cm) si 2 sine suport



Raft Intermediar (potrivit pentru marimile 160 & 190)

2 bucati, raft din otel galvanizat cu sine suport, tine o greutate de 100 kg, poate fi folosit si ca raft din 2 piese, inaltime ajustabila in 5 pozitii diferite, usor de modificat.



Highboard Marime 160, Gri inchis metalizat
(cu suport unelte si etajera intermediara ca accesorii)

HighBoard

lese in evidenta
in curte

Multitalent pentru depozitare

Datorita usilor duble si a capacului care se deschide, HighBoard se poate folosi la orice: ca spatiu unde sa va tineti pernele de terasa sau uneltele pentru gradina, ca extensie perfecta pentru bucataria de vara, totul este protejat de intemperii si pastrat curat si ordonat. Designul lui elegant a fost conceput de designeri industriali si garantat iese in evidenta in orice gradina.

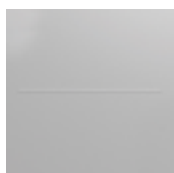

Argintiu
Metalizat



Gri cuart
Metalizat



Gri Inchis
Metalizat



Marime 160, Gri cuart metalizat cu etajera intermediara



Avantaje

- Etans impotriva apei de ploaie
- Sistem ventilatie integrat invisibil
- Suprafete fara suruburi si nituri

Siguranta:

- Mecanism inchidere cu incuietoare rotativa cilindrica

Functionalitate:

- Deschidere capac cu arc hidraulic

Dotare standard:

- deschizator capac tomberon (3 buc.)

Info produs



Marime (in cm)

Deschidere usa:

Marime 160: 140 x 100 cm (l x H)

Marime 200: 167 x 110 cm (l x H)

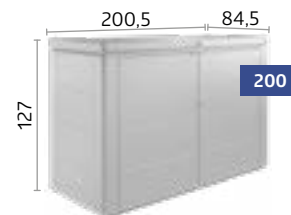
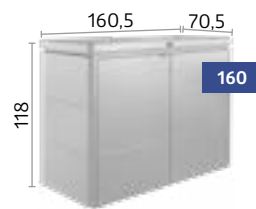

★ Accesorii optionale disponibile



Cos Suspendat

Sacul din plasa de poliester negru ofera spatiu aditional de depozitare si pur si simplu se agata de cadru. Capacitate de incarcare max. 10 kg.



Suport Unelte

Pentru a fi montat in interiorul usii. Max. 2 suport unelte per panou usa



Raft Intermediar

Argintiu Metalizat, 9 pozitii ajustabile pe inaltime. Usor de instalat si adaptabil universal (de ex. ca un raft unit sau ca 2 rafturi). Capacitate de incarcare max. 50 kg



Plasa depozitare la capac

Solutia pentru obiecte mici. poate fi atasat cu usurinta in interiorul capacului.



LoungeBox® Marime 160, Gri inchis metalizat

LoungeBox®

Eleganta Stilata

Design pentru standard inalt

LoungeBox® este solutia perfecta pentru perne de terasa sau alte lucruri pentru care e greu de gasit un loc potrivit. Datorita aspectului sau frumos, se potriveste foarte bine in fiecare curte.

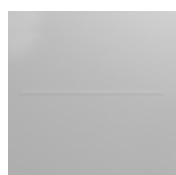

Argintiu
Metalizat



Gri cuart
Metalizat



Gri Inchis
Metalizat



Marime 160, Gri inchis metalizat



Avantaje

- Etans impotriva apei de ploaie
- Sistem ventilatie integrat invisibil
- Capac din aluminiu
- Suprafete fara suruburi si nituri

Siguranta:

- Mecanism inchidere cu incuietoare rotativa cilindrica

Functionalitate:

- Deschidere capac cu amortizor

Info produs



Marime (in cm)

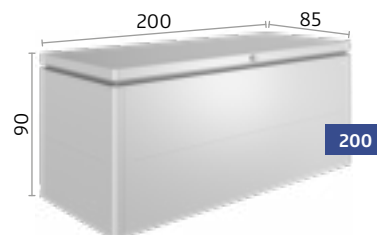
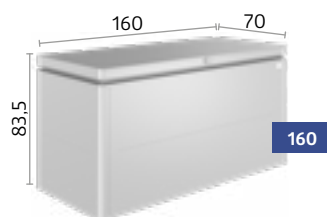

★ Accesorii optionale disponibile



Cos Suspendat

Sacul din plasa de poliester negru ofera spatiu aditional de depozitare si pur si simplu se agata de cadru. Capacitate de incarcare max. 10kg.



Plasa depozitare la capac

Solutia pentru obiecte mici. Poate fi atasat cu usurinta in interiorul capacului.



StyleBox® Marime 170, Gri inchis metalizat

StyleBox®

Pentru mai mult stil

Depozitarea ca element de design

Noua cutie de depozitare pentru exterior se prezinta intr-un mod de mare calitate si stil datorita suprafetei sale fine si finisajelor fara cusur. Prin sistemul inovativ cu clic il assemblezi in 20 de minute. Fie pe o terasa, pe balcon sau in gradina- designul sau se potriveste perfect in orice spatiu.

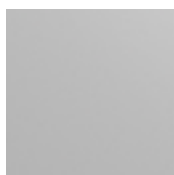

Argintiu Metalizat



Gri cuart Metalizat

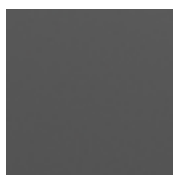

Gri Inchis Metalizat



Marime 170, Gri cuart metalizat
cu cos suspendat si plasa depozitare la capac



Avantaje

- Etans impotriva apei de ploaie
- Sistem ventilatie integrat invisibil
- Design elegant cu suprafete fine
- Asamblare rapida pe care o poti face singur in mai putin de 20 de minute datorita sistemului inovativ de imbinare clic

Siguranta:

- Se poate incuia cu lacat (lacatul nu este inclus)

Functionalitate:

- Deschidere capac cu amortizor
- Inchidere rapida

Dotare standard:

- Cu picioare ajustabile pentru a compensa suprafata denivelata

Info produs



Marimile (in cm)

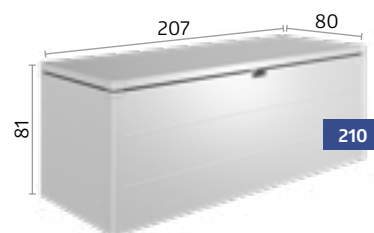
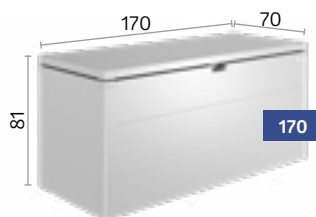
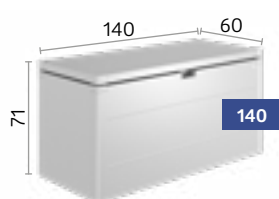

★ Accesorii optionale disponibile



Cos Suspendat

Sacul din plasa de poliester negru ofera spatiu aditional de depozitare si pur si simplu se agata de cadru. Capacitate de incarcare max. 10kg.



Plasa depozitare la capac

Solutia pentru obiecte mici. Poate fi atasat cu usurinta in interiorul capacului.



Roti

Doua roti cauciucate pentru mutarea cutiei





LeisureTime Box marime 160^{HIGH}, gri cuart metalizat

LeisureTime Box

Cu Stil si Durabil

Cutia perfecta pentru exterior

Aici poti depozita toate acele lucruri pentru care nu gasesti un loc potrivit Ideal pentru depozitarea pernelor de scaune, jucariilor, scaunelor de plaja, scaunelor pliante, echipamentului de sport sau camping. 5 marimi, 5 culori pentru fiecare. Solutia durabila perfecta datorita folosirii materialelor de cea mai buna calitate.



Alb



Argintiu
Metalizat



Gri cuart
Metalizat

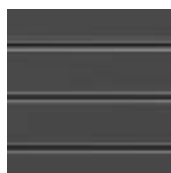

Gri Inchis
Metalizat



Bronz
metalizat



Avantaje

- Etans impotriva apei de ploaie
- Sistem ventilatie integrat invisibil

Siguranta:

- mecanism inchidere in 2 pozitii cu maner in T incuietoare cilindrica

Functionalitate:

- Deschidere capac cu amortizor

Info produs



Marime (in cm)

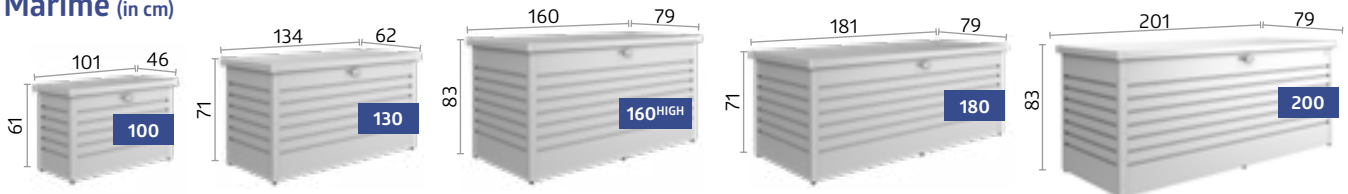

Sfat: Ideal si pe post de cutie depozitare colete!

★ Accesorii optionale disponibile



Cos Suspendat

Sacul din plasa de poliester negru ofera spatiu aditional de depozitare si pur si simplu se agata de cadru. Capacitate de incarcare max. 10 kg.



Plasa depozitare la capac

Solutia pentru piese mici poate fi atasata cu usurinta in interiorul capacului. Doua plase pot fi fixate una langa alta in LeisureTime Box 180.



Kit cutie colet

Bara de blocare din otel inoxidabil si lacat cu combinatie de numere si cablu din otel inoxidabil.





DIN DRAGOSTE PENTRU BICICLETA TA



50 MiniGarage



52 StoreMax®



54 HighBoard

Sfat: casele de gradina de la Biohort ofera suficient spatiu pentru depozitarea in siguranta a bicicletelor. Pentru detalii ,vezi pag. 8-27.



MiniGarage Marime L, Gri inchis metalizat
 (Cu rama si podea din aluminiu, sine pentru fixare biciclete, panou montaj electrice si set de rafturi ca accesorii)

MiniGarage

Mic dar cu
beneficii mari

Garaj pentru depozitarea bicicletelor sigur si practic

MiniGarajul este solutia ideala pentru depozitarea a pana la doua biciclete sau a uneltelor sau mobilierului de gradina. Sistemul inteligent de sine (optional) faciliteaza depozitarea bicicletelor: Fixati roata din fata in sina de ghidaj impingeti pana cand roata din fata este in clema, gata! Setul de rafturi este ideal pentru depozitarea accesorilor pentru bicicleta.

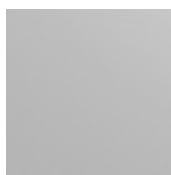

Argintiu
Metalizat

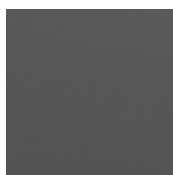

Gri Inchis
Metalizat



Marime L, Gri inchis metalizat
 cu sina pentru bicicleta, panou montaj electrice si set de rafturi



Avantaje

- Etans impotriva apei de ploaie
- Sistem ventilatie integrat invisibil

Siguranta:

- mecanism inchidere in 3 pozitii cu maner in T incuietoare cilindrica

Functionalitate:

- Deschidere usa confortabila cu arc hidrolic

Dotare standard:

- Sistem organizare in interiorul usii (include 6 carlige)

Info produs



Marimile (in cm)

Deschidere usa:
125 x 137 cm (l x H)

Dimensiuni interioare:
140 x 195 x 143 cm (L x l x H)

Capacitate de depozitare:
2 biciclete de adulti (va rugam sa verificati dimensiunea bicicletelor, vezi www.biohort.com pentru mai multe informatii)

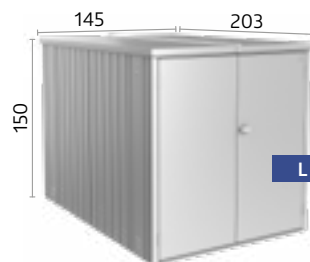

★ Accesorii optionale disponibile



Sina pentru bicicleta

Panoul este montat pe perete spate. Sina de ghidaj este agatata la inaltimea dorita si permite depozitarea facila a bicicletei si manipulare usoara.
Maxim doua sine depozitare bicicleta.
Latimea max. a cauciucului: 70 mm, lungimea max. a bicicletei: 1,92 m:



Set rafturi

2 rafturi de otel (77 x 268 cm) si 2 sine suport.



Panou montaj electric

Positionarea usoara si discreta a cablurilor, asamblare usoara a intreruptoarelor si prizelor (echipamentul din poza nu este inclus).
Include 2 sine suport.



Solutii Fundatie

Rama din aluminiu /
Panouri podea din aluminiu
SmartBase / SmartBase^{PLUS}

Pentru detalii, vezi paginile 30 – 33.



StoreMax® Marime 190, Argintiu Metalizat

StoreMax®

Ridici usa culisanta
si scoti bicicleta

Arata super

In fata casei,gata imediat: garajul pentru depozitarea bicicletei StoreMax® cu rastelul pentru biciclete ofera maxim de spatiu de depozitare fara sa ocupe mult spatiu - dimensiunea perfecta pentru pana la 2 biciclete. Sistemul cu usa culisanta tip rulou te ajuta sa-ti economisesti energia pentru tura de bicicleta si iti protejeaza bicicleta printr-o incuietoare cilindrica robusta.



Argintiu
Metalizat



Gri cuart
Metalizat



Gri Inchis
Metalizat



Usa rulanta din partea de sus se poate deschide separat.



Pentru a deschide complet StoreMax® partea din fata culiseaza complet in spate.



Avantaje

- Etans impotriva apei de ploaie
- Usi rulante din aluminiu

Siguranta:

- mecanism inchidere in 2 pozitii cu maner in T incuietoare cilindrica

Functionalitate:

- O operatie usoara datorita sistemului cu arc

Dotare standard:

- Suport unelte pe interiorul peretilor laterali

Info produs



Marime (in cm)

Dimensiuni interioare:

188 x 86 cm (l x H)

Capacitate de depozitare:

2 biciclete de adulti (va rugam sa verificati dimensiunea bicicletelor, vezi www.biohort.com pentru mai multe informatii)

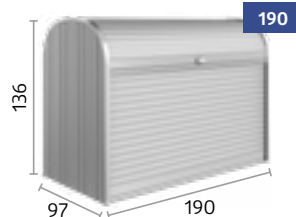

★ Accesorii optionale disponibile



Sistem fixare bicicleta BikeHolder

Placa de baza include sistemul de prindere care se fixeaza in doua sine suport si asigura depozitarea optima pentru doua biciclete.



HighBoard Marime 200, Gri quart metalizat
(cu sistem de fixarea bicicletei ca accesoriu)

HighBoard

Un spatiu generos
pentru bicicleta ta

Pastreaza-ti lucrurile de valoare in siguranta

Mersul pe bicicleta te tine in forma iar HighBoard iti tine bicicleta in stare perfecta: apa nu patrunde, aerisit, sistem de fixare a bicicletelor si sistemul de inchidere cilindric, robust care te protejeaza de furt. Pana la doua biciclete pot fi depozitate si scoase cu usurinta si datorita capacului care se poate deschide. Deci nimic nu sta in calea unei ture spontane pe bicicleta.



Argintiu
Metalizat



Gri quart
Metalizat

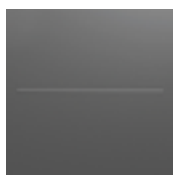

Gri Inchis
Metalizat



**Marime 200, Gri quart metalizat cu sistem
fixare bicicleta BikeHolder**



Avantaje

- Etans impotriva apei de ploaie
- Sistem ventilatie integrat invisibil
- Suprafete fara suruburi si nituri

Siguranta:

- Mecanism inchidere cu incuietoare rotativa cilindrica

Functionalitate:

- Deschidere capac cu arc hidraulic

Dotare standard:

- deschizator capac tomberon (3 buc.)

Info produs



Marime (in cm)

Deschidere usa:
167 x 110 cm (l x H)

Dimensiuni interioare:
195 x 76 x 120 cm (Lx l x H)

Capacitate de depozitare:
2 biciclete de adulti (va rugam sa verificati dimensiunea bicicletelor, vezi www.biohort.com pentru mai multe informatii)

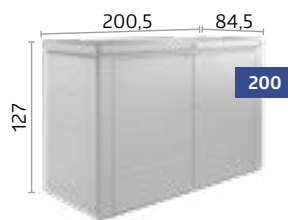

★ Accesorii optionale disponibile



Sistem Fixare Bicicleta BikeHolder

Placa de baza include sistemul de prindere care se fixeaza in doua sine suport si asigura depozitarea optima pentru doua biciclete.



Panou montaj electric

Pozitionarea usoara si discreta a cablurilor, asamblare usoara a intrerupatoarelor si prizelor (echipamentul din poza nu este inclus).



Support Unelte

Pentru a fi montat in interiorul usii.
Max. 2 suport unelte per panou usa.



Plasa depozitare la capac

Solutia pentru obiecte mici. Poate fi atasat cu usurinta in interiorul capacului.



**CEL MAI FRUMOS
MOD DE A SEPARA
DESEURILE**



58 Alex®



60 StoreMax®



62 HighBoard



Doua cutii Dustbin Boxes Alex®, gri cuart metalizat

Alex®

Cutie Depozitare Pubela Modulara

Design modern, detalii inteligente

Cu noul sistem de depozitare pubele Alex®, orice numar de cutii poate fi asezat in rand, chiar si ulterior, si astfel sistemul de separare se poate ajusta optim. Pubela se poate deschide usor, sistemul de fixare o tine in pozitie inclinata si astfel poti sa o umpli. Cu designul sau modern Alex® face o figura frumoasa in curte!

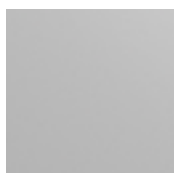

Argintiu Metalizat

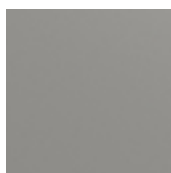

Gri cuart Metalizat

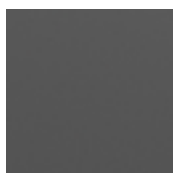

Gri Inchis Metalizat



Doua cutii Dustbin Boxes Alex®, gri cuart metalizat

O podea functionala cu lacas pentru roti



Avantaje

- Se poate extinde dupa preferinte datorita designului modular
- Sistem de ventilatie integrat
- Acoperis stabil
- Etans impotriva apei de ploaie

Siguranta:

- Mecanism inchidere cu incuietoare rotativa cilindrica

Dotare standard:

- Sistem de inclinare a toberonului
- O podea functionala cu lacas pentru roti
- Sistem organizare in interiorul usii (include 3 carlige)

Info produs



Marime (in cm)

Deschidere usa:

65 x 118 cm (l x H)

Disponibil cu balamale la usa pe stanga

Capacitate de depozitare:

pubela 120 L sau

pubela 240 L

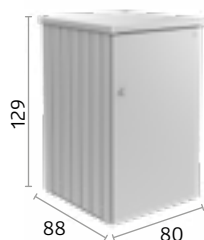

★ Accesorii optionale disponibile

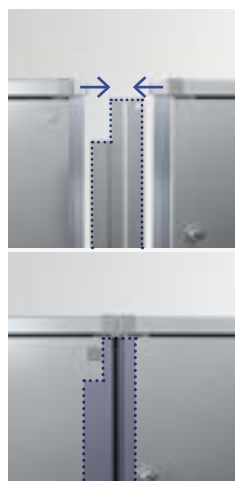

Element de conectare

Acopera distanta dintre doua cutii depozitare pubele



Incuietoare cilindrica potrivita

Daca aveti mai multe cutii ele pot avea o singura cheie.



Rafturi si sine suport (2 buc.)

Rafturi din otel galvanizat (72 x 24,5 cm) montate pe sinele suport
Max. 4 rafturi per cutie depozitare pubela.



StoreMax® Marime 160, Gri inchis metalizat

StoreMax®

Acoperire rafinata
a pubelelor

Functionalitate eleganta

Pana la trei pubele de 240 L se pot ascunde in spatele capacului culisant. Sistemul de deschidere in doua parti, cu capacul culisant care se deschide separat permite un acces usor la pubelele ascunse-si la scoaterea usoara a pubelelor cand cutia este complet deschisa.



Argintiu
Metalizat



Gri cuart
Metalizat



Gri Inchis
Metalizat



Usile rulante din partea de sus se pot deschide separat.



Pentru a deschide complet StoreMax® partea din fata culiseaza complet in spate.



Avantaje

- Etans impotriva apei de ploaie
- Usi rulante din aluminiu

Siguranta:

- mecanism inchidere in 2 pozitii cu maner in T incuietoare cilindrica

Funcionalitate:

- O operatie usoara datorita sistemului cu arc

Dotare standard:

- Suport unelte pe interiorul peretilor laterali

Info produs



Marime (in cm)

Capacitate de depozitare:

Marime 120: 2 pubele x 120 L

Marime 160: 3 pubele x 120 L sau 2 pubele x 240 L

Marime 190: 3 pubele x 120 L sau 3 pubele x 240 L

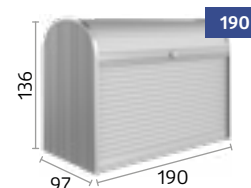
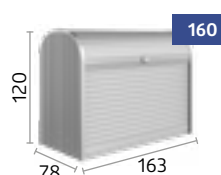
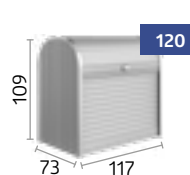

★ Accesorii optionale disponibile



Set rafturi pe colt (potrivit pentru marimile 120 & 160)

2 rafturi (triunghiulare) cu sine suport, inaltime ajustabila in 5 pozitii diferite, usor de modificat, se poate monta in stanga sau in dreapta, cum doriti.





HighBoard Marime 200, Argintiu Metalizat

HighBoard

Ceva nobil in
gradina din afara
casei

Inesteticul intr-o forma frumoasa

Pubelele nu sunt placute vederii – daca nu sunt ascunse intr-un design nobil. Additional HighBoard iti permite sa umpli si sa golesti usor pubelele datorita usilor largi si a capacului care se deschide. Incuietoarea cilindrica robusta nu permite altora sa-ti foloseasca pubela.

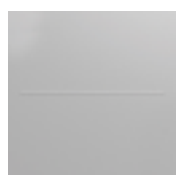

Argintiu
Metalizat



Gri cuart
Metalizat



Gri Inchis
Metalizat



Marime 200, Gri cuart metalizat



Avantaje

- Etans impotriva apei de ploaie
- Sistem ventilatie integrat invisibil
- Suprafete fara suruburi si nituri

Siguranta:

- Mecanism inchidere cu incuietoare rotativa cilindrica

Functionalitate:

- Deschidere capac cu arc hidraulic

Dotare standard:

- deschizator capac tomberon (3 buc.)

Info produs



Marime (in cm)

Deschidere usa:

Marime 160: 140 x 100 cm (l x H)

Marime 200: 167 x 110 cm (l x H)

Capacitate de depozitare:

Marime 160: 3 pubele x 120 L

Marime 200: 3 pubele x 120 L sau 3 pubele x 240 L

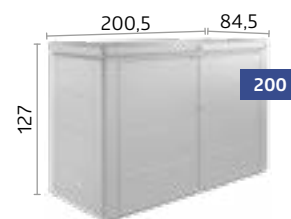
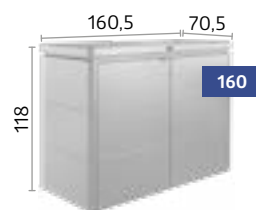

★ Accesorii optionale disponibile



Support Unele

Pentru a fi montat in interiorul usii.
Max. 2 suporturi unelte per panou usa.



AICI **PROSPER**



66 Rasadnita



68 Belvedere®



72 DaVinci®



Rasadnita 2 x 1, argintiu metalizat

Rasadnita

Cultivare Inteligenta

Cele mai bune conditii pentru o recolta bogata!

Rasadnitele fac ca experienta cultivarii plantelor sa fie mai usoara si maximizeaza recolta- dar doar rasadnita de la Biohort perfectioneaza cel mai frumos hobby din lume prin designul inteligent si functionalitate practica. Detalii ingenioase contribuie la frumusetea acestui produs, care ofera mai mult decat un aspect frumos!



Argintiu Metalizat



Gri cuart Metalizat



Gri Inchis Metalizat



Marimea 2x1, gri inchis metalizat cu rama extensie pentru inghet culoare gri cuart metalizat



Avantaje

- Extrem de durabil
- Se assembleaza rapid - doar 8 suruburi
- Inaltime optima de lucru
- Suprafete fara suruburi si nituri

Siguranta:

- Protectie impotriva rozatorilor din fibra de sticla integrata

Functionalitate:

- Protectia impotriva melcilor, bordura, rama protectoare la inghet, spalierul si nivelul intermediar sunt disponibile optional.
- Peretii laterali culisanti permit o golire usoara
- Deschidere pentru furtun irigare
- Locul ideal pentru a recicla resturile din gradina!

Info produs



Marime (in cm)

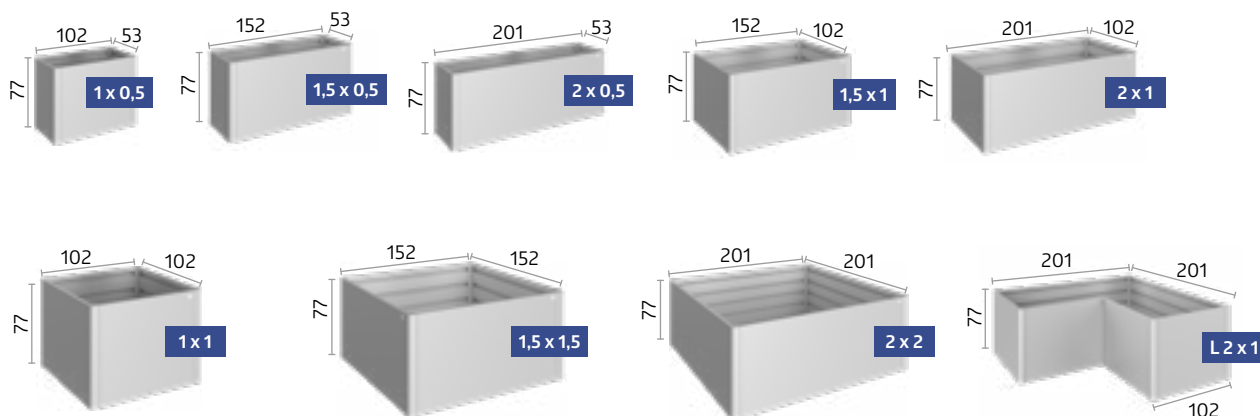

★ **Accesorii optionale gasiti la paginile 70 - 71.**



Belvedere® L150^{MAXI}, gri cuart metalizat

Belvedere®

Design
experimental

Atrage toate privirile pe terasa ta

Cu o latime de doar 50 cm jardiniera Belvedere® creaza un spatiu pentru idei speciale: ca separator din plante al unui spatiu, adauga o structura curtii sau gradinii tale si iti infrumusesteaza balconul. Acest produs iti da complet noi posibilitati de design.

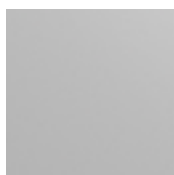

Argintiu
Metalizat



Gri cuart
Metalizat

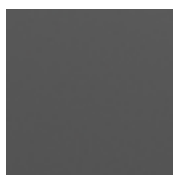

Gri Inchis
Metalizat



Marimea L100 argintiu metalizat cu spalier



Avantaje

- Extrem de durabil
- Asamblat rapid
- Suprafete fara suruburi si nituri

Siguranta:

- Protectie impotriva rozatorilor din fibra de sticla integrata

Functionalitate:

- Bordura, spalier, paravan si insertul de ghiveci sunt disponibile optional.
- Deschidere pentru furtun irigare

Dotare standard:

- Raft intermediar

Info produs



Marime (in cm)

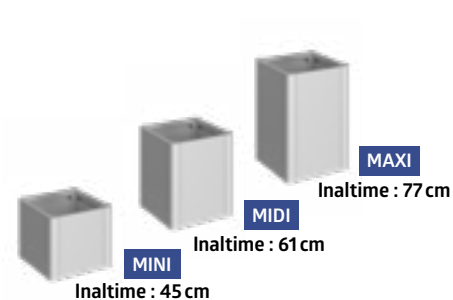
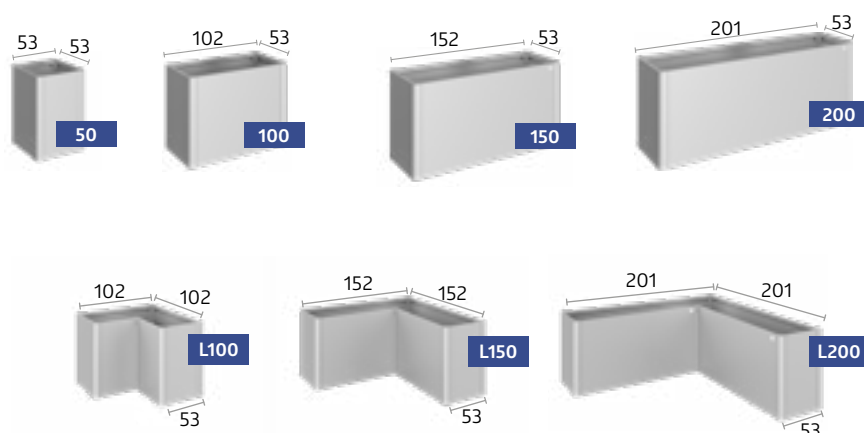



















Sfat: Toate marimile sunt disponibile in 3 inaltimi diferite!

★ **Accesorii optionale gasiti la paginile 70 – 71.**

 **Echipament standard**

 **Accesorii optionale disponibile**

		Rasadnita	Belvedere®
01	Panoul culisant* Usor de golit datorita panoului culisant.		
02	Pregatire pentru irigare Deschizatura pentru furtul pe latura ingusta (marime: 17 x 17 mm, cu exceptia marimii 2 x 2 si 1,5 x 1,5).		
03	Protectie impotriva rozatorilor Protectie impotriva rozatorilor din fibra de sticla integrata. Se insereaza inainte de umplere.		
04	Nivel Intermediar* Nivelul intermediar reduce volumul jardineriei si cantitatea de pamant necesara, si astfel economisiti bani si timp pretios. Se aseaza pe a doua striatie in timpul asamblarii.		
05	Rama extinsa pentru protectie la inghet* Protecte inghet cu 4 panouri culisante care se pot inlatura usor. Rezistent la vant si dotat cu sistem de scurgere a apei (potrivit pentru marimea 2x1). Nu se poate asambla cu spalier (09).		
06	Protectie impotriva melcilor* Se monteaza deasupra jardineriei. Se poate asambla cu extensia de protectie impotriva inghetului (05). Nu este disponibil pentru marimile L.		
07	Bordura* Bordura se monteaza pe rama de podea si se aseaza pe sol. Apoi jardiniera se monteaza pe bordura si se fixeaza (nu se poate instala ulterior). Latime: 6,7 cm		
08	Insert pentru ghiveci Insertul de plastic (marime: 0,5 x 0,5 m) pentru o plantare usoara este amplasat pe nivelul intermediar. Se pot da gauri pentru drenaj fara probleme.		
09	Spalier* Spalierul este atasat direct la jardiniera/rasadnita. Nu se poate monta impreuna cu rama de protectie la frig (05) sau cu protectia impotriva melcilor (06). Inaltime: 91 cm		
10	Paravan* cu sau fara panouri din acril Paravanul impreuna cu jardiniera formeaza o legatura decorativa care nu doar te ascunde dar te si protejeaza de vant. Nu se poate monta impreuna cu rama de protectie la frig (05) sau cu protectia impotriva melcilor (06). Inaltime: 91 cm Nota: In locuri in care bate vant puternic, la produsul cu paravan exista riscul sa se rastoarne, de aceea este esential sa aveti o fixare in sol adecvata - sa folositi materialele de fixare pe care le primiti de la producator.		
11	Variante de inaltime Cele trei inaltime ale jardinerelor iti permit sa le asezi dupa cum doresti. Inaltime: 45 cm (Mini), 61 cm (Midi) si 77 cm (Maxi)		

*Fabricate din otel galvanizat cu protectie din poliamida



01 Panou culisant



02 Pregatire pentru irigare



03 Protectie impotriva rozatorilor



04 Nivel intermediar



05 Rama extinsa pentru protectie la inghet



06 Protectie impotriva melcilor



07 Bordura



08 Insert pentru ghiveci



09 Spalier



10 Paravan cu sau fara panouri din acril



11 Variante de inaltime

Cauti o solutie personalizata?

DaVinci®

Sistem modular





DaVinci® Gri cuart metalizat
Combinatie de diferite inaltimi, lungimi si paravane si spalieri

DaVinci®

Sistem Plantare Flexibil

Individualitate nelimitata

Construieste-ti sistemul de jardiniere DaVinci® asa cum doresti. De la simpla jardiniere cu inaltime variabila la paravan si margine de terasa, posibilitatile sunt nenumarate. Modulele de baza in versiuni diferite se pot combina individual. Cu ajutorul Configuratorului 3D DaVinci® poti sa-ti vizualizezi sistemul cu cateva clickuri.

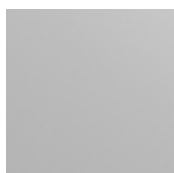

Argintiu
Metalizat

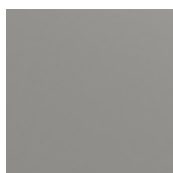

Gri cuart
Metalizat

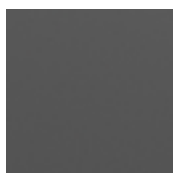

Gri Inchis
Metalizat



DaVinci® ca Jardiniera
Combinatie de diferite inaltimi si lungimi.



Avantaje

- Configurabil individual
- Extrem de durabil
- Disponibil in diferite lungimi, inaltimi si combinatii
- Suprafete fara suruburi si nituri

Functionalitate:

- Paravanul si spalierul se pot pozitiona cum doriti
- Ideal ca margine pentru o terasa

Dotare standard:

- Raft intermediar

Info produs

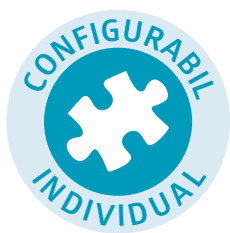

3 inaltimi, 4 latimi, 3 culori si posibilitati nenumarate

Inaltime de la 45 cm la 77 cm si lungime de la 50 cm la 200 cm.

Datorita sistemului modular dorintele voastre pot fi nelimitate. Modulele de baza se pot aranja in orice ordine. Paravanul si spalierul se pot pozitiona asa cum doriti

Configureaza-ti propriul sistem de ghiveci modular DaVinci® acum!
www.biohort.com/configurator

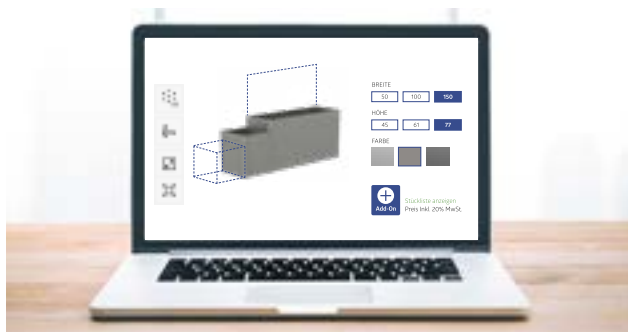

Configureaza-ti propriul sistem de ghiveci modular DaVinci® acum!
biohort.com/configurator sau codul QR de mai sus.

Configuratii flexibile, convenabile si versatile



DaVinci® ca paravan

Combinatie de diferite inaltimi, lungimi si doua paravane.

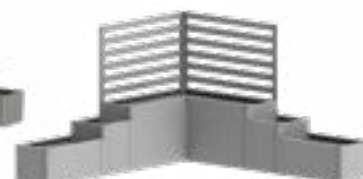

DaVinci® ca Bordura pentru terasa

Combinatie de diferite inaltimi, lungimi si doua spalieri.



TOTUL
PENTRU OAZA
TA **DE AFARA**



76 Paravan



78 MonAmi®



79 Charly®



80 WoodStock®



Paravan cu panou de acril
Gri Inchis Metalizat

Paravan

Atrage Privirea

Ceva privat

Paravanele noastre te protejeaza nu doar de ochi curiosi ci si de vant si soare. Datorita sistemului de fixare, elementele se pot extinde individual. Indiferent daca este de sine statator sau este fixat pe un perete - Paravanul de la Biohort este delimitarea perfecta pentru oaza ta din gradina.



Argintiu
Metalizat



Gri cuart
Metalizat

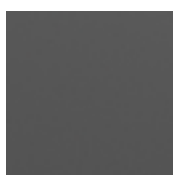

Gri Inchis
Metalizat

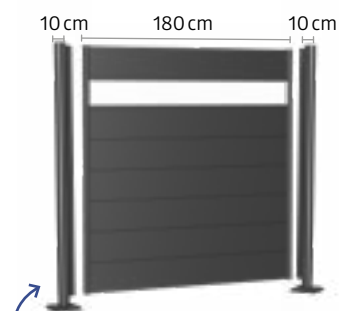

Paravanul consta din:
Panouri si stalpi

Stalpii pot fi la folositi ca ultim element al paravanului sau ca si colt sau element de legatura intre doua panouri.



Avantaje

- Configurabil individual
- Extrem de durabil
- Asamblare simpla
- Paravan de protectie la vant si soare
- Suprafete fara suruburi si nituri

Siguranta:

- Rezistenta la vant datorita ancorarii la sol bine concepute

Functionalitate:

- Un ansamblu de sine statator sau legat la peretele casei sau la ceva similar
- Accesorii pentru asamblare disponibile optional (vezi detalii tehnice)

Info produs



Marime (in cm)

Stalpi:

Inaltime ajustabila:
pana la 25 cm
Diametru: 10 cm

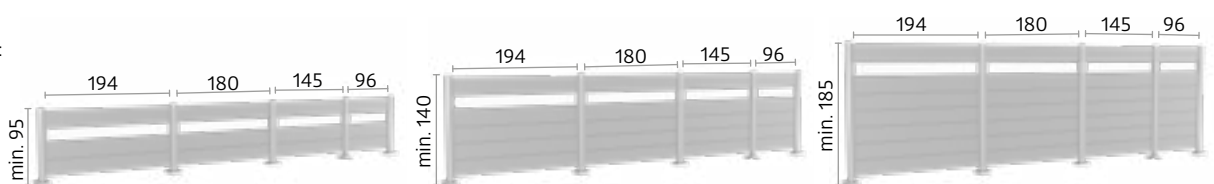

★ Accesorii optionale disponibile

Componente

Un paravan este alcatuit din panou perete (cu sau fara panou de acril) si stalpi.



Paravan Combinatii posibile

Paravanul poate fi asezat in linie dreapta sau in unghiuri de 90°.

Toate latimile si inaltimele sunt compatibile intre ele, facand posibile si gradatiile pe inaltime.



Varianta 1: Stalp pentru fixare, inaltime ajustabila pana la 25 cm

Baza este fixata in fundatie de beton folosind batoane de fixare (disponibile optional). Montajul pe gresie de exterior sau podea de lemn/WPC nu este suficient.

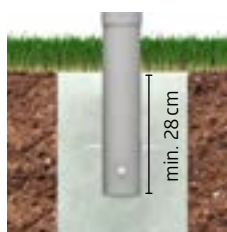

Varianta 2: Stalp pentru fixare in beton, inaltime ajustabila pana la 25 cm

La aceasta varianta, stalpul este fixat direct in beton
Marimea punctelor de fundatie:
min. 50 x 50 cm (variaza in functie de conditiile de sol)
adancimea min.: 80 cm (variaza in functie de inaltimea paravanului)



MonAmi®, Gri Inchis Metalizat

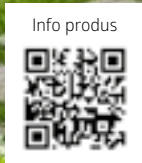

MonAmi®

Compostor

"Prietenul meu" din gradina, compostorul MonAmi® combina functionalitatea cu aspectul stilat: elegant, suprafete netede la exterior, in interior are tot ce-i trebuie pentru compostare eficienta. Doua tevi de ventilatie amplasate central creaza un efect de cos si asigura o circulatie corespunzatoare a aerului, in timp ce spatiul de sub capac asigura transferul caldurii in exterior. Chiar si compostarea resturilor poate arata grozavi!

Avantaje

- Extrem de durabil
- Suprafete fara suruburi si nituri

Functionalitate:

- Protectie impotriva rozatorilor din fibra de sticla integrata

Dotare standard:

- Sistemul de ventilatie asigura un proces optim de descompunere.
- Panoul frontal culisant il face practic si usor de golit.
- Deschidere capac cu amortizor

Marime (in cm)

Volum:
725 l

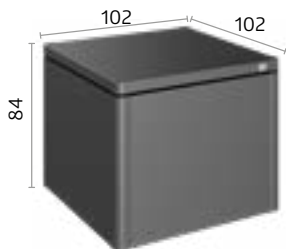

Gri Inchis
Metalizat

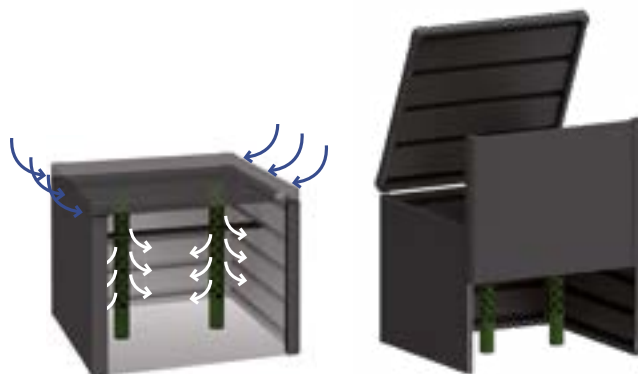

Tevi de ventilatie

Tevile de ventilatie integrate asigura necesarul de oxigen si circulatia aerului, esentiala pentru procesul de descompunere.

Panoul culisant

Panoul frontal culisant il face practic si usor de golit.

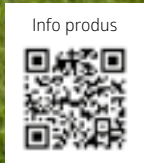

Charly® Marime 2

Charly®

Garaj pentru Robot de Tuns Iarba

Harnicul robot de tuns iarba nu doar ca are nevoie de adpost cand ploaua, este chiar recomandat sa-l protejezi de ploaie! Capacul care se pliaza ofera un acces usor la panoul de control.

Avantaje

Siguranta:

- Capac cu inchidere in trepte
- Coltare de protectie
- Fixare la sol cu suruburi

Functionalitate:

- Acces usor la panoul de comanda datorita capacului cu inchidere in trepte

Marime (in cm)

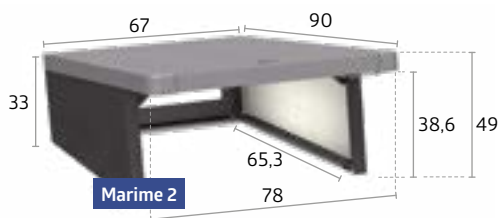

Capac cu inchidere in trepte

Capacul care se pliaza, cu mecanismul lui de inchidere ofera un acces usor la panoul de control.

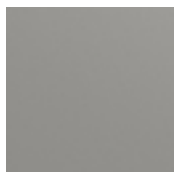

Capac:
Gri cuart
Metalizat



Pereti laterali:
Gri Inchis
Metalizat



WoodStock® Marime 230, Gri inchis metalizat

WoodStock®

Bun la toate

Depozitarea lemnului de foc dar si Dulap de unelte in acelasi timp

Nimic nu face o atmosfera mai calda decat un focul din semineu intr-o zi rece de iarna. Dar unde sa depozitam lemnele? WoodStock® vine cu solutia ordonata si de durata, la aceasta intrebare. In timpul verii iti ofera mult spatiu pentru depozitarea mobilierului de gradina si al uneltelor. Posibilitatea atasarii de casa s-a dovedit a fi foarte practica.



Argintiu Metalizat



Gri cuart Metalizat



Gri Inchis Metalizat



WoodStock® Marime 300, Gri cuart metalizat



Avantaje

- Stabil datorita ramei masive din aluminiu

Siguranta:

- Burlan integrat in partea din fata
- Aplicabil universal la toate casele de gradina
- O mare varietate de accesorii disponibile

Funcionalitate:

- Suruburi de fixare si ancorare pentru fundatie

Info produs



Marimile (in cm)

Volum:

Marime 150: 2,1m³

Marime 230: 3,1m³

Marime 300: 4 m³

Este posibil sa depozitati lemnele pe doua randuri (lungimea maxima la lemnului: 35 cm)

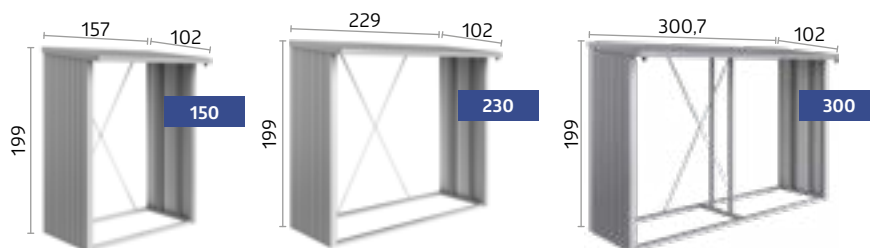

★ Accesorii optionale disponibile



Panou podea din aluminiu

Placile din aluminiu de cea mai buna calitate, protejeaza lemnul si uneltele de gradina de umezeala.



Pachet usa

(potrivit pentru marimile 150 & 230)

Usa dubla cu clanta cilindrica in T si sistem de organizare pe interiorul usii, Deschiderea usii: 135 x 171 cm (l x H).



Perete spate

Fabricate din otel galvanizat cu protectie din poliamida.

De ce Metal:

- + Fara vopsea
- + Otelul de inalta calitate folosit de Biohort nu se deformeaza si ramane neschimbat zeci de ani.
- + Otelul galvanizat si protejat cu un email de poliamida folosit de Biohort este ignifug conform cu EN 13501-1 (Clasa "A1").
- + Chiar si producatorii de autoturisme germane premium au incredere in aceleasi otel.

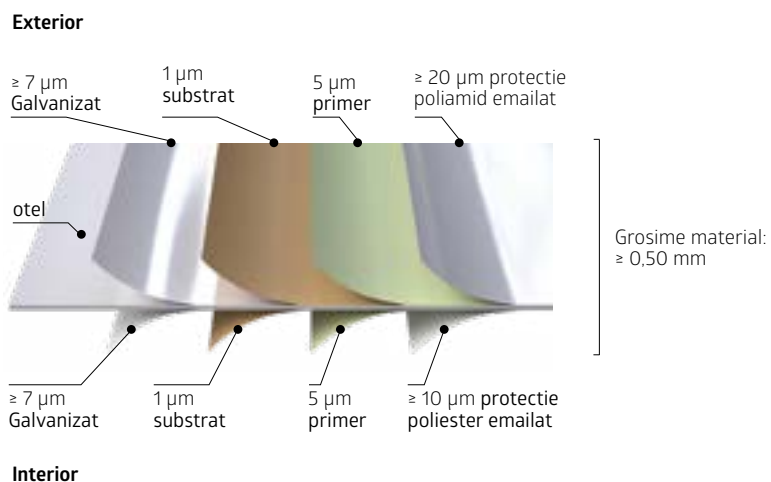

Stiai ca?



Test de Stabilitate

Testul efectuat in tunelul vantului la Universitatea de Tehnologie din Viena certifica faptul aceste case de gradina de la Biohort rezista la o forta a vantului pana la 150km/h(forta 12)atunci cand sunt asamblate si ancorate corect. Profile cu design optim si folosirea suruburilor din otel inoxidabil contribuie la durabilitatea produselor noastre.



Material

Biohort foloseste **otel galvanizat la cald** si aditional **o emailare la cald** cu poliamida. De aceea Biohort acorda **20 de ani garantie** impotriva corozioni fara dubii. Aceasta garantie se aplica doar cu conditia ca substante agresive (exemplu cloruri, sare etc.) sa nu fie depozitate sa nu existe conditii de mediu agresive. De exemplu casuta sa fie foarte aproape de mare sau sarea de pe sosea.



Culori Biohort

Lacurile colorate folosite sunt produse special pentru noi si nu corespund nici unui **numar RAL**. Datorita faptului ca multi dealeri au casute model sau mostrar de culoare va recomandam sa-i vizitati inainte de comanda. Mai mult, puteti solicita mostre de culoare gratuite (mostrar de culoare) pe site-ul nostru!



Sustenabilitatea este punctul nostru

Afacerea noastră de familie se concentrează pe sustenabilitatea fără compromisuri de 30 de ani. Suntem conștienți de responsabilitatea noastră și întotdeauna acționăm conform convingerilor noastre: **Acțiunile de astăzi au un impact decisiv asupra zilei de mâine - economic, ecologic și social!**

Iubim mediul inconjurător

Ne focusăm pe un mod de producție sustenabil și prietenos cu mediul. Produsele Biohort au o **durată mare de viață** și otelul folosit este 100% reciclabil. Livrarea rapidă și rutele de transport asigură emisii scăzute de CO₂ iar **ambalajul nostru** este făcut aproape în totalitate din material reciclabil. Transportul între fabrici este efectuat 100% cu **vehicule electrice**.

Toate clădirile companiei noastre sunt dotate cu **sisteme fotovoltaice**. Cu energia solară pe care o producem noi, ne acoperim o treime din consumul anual al producției noastre. În momentul de față acoperim 10 % din consumul pentru încălzire al companiei cu **pompe de căldură** și în viitor încă 50% cu **încălzire din biomasa** din reziduri de lemn. În total, aproape jumătate din consumul de energie poate fi acoperit din sursele noastre proprii, sustenabile.



Otelul este 100% reciclabil



Furnizori locali









Producție în Austria



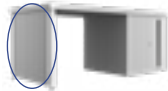

Surse sustenabile de energie

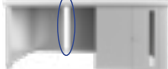

Casa de gradina

Neo	Marime	Dimensiuni exterioare*	Dimensiuni interioare	Dimensiunile fundatiei	Greutate	Cod EAN		
		l x L x H (cm)	l x L x H (cm)	l x L (cm)	(kg)	Argintiu Metalizat	Gri cuart Metalizat	Gri Inchis Metalizat
Cu usa standard, deschidere usa: 83 x 200 cm (l x H), balama deschidere pe dreapta								
	1A	180 x 180 x 222	164 x 164 x 208	173 x 173	211,5	9003414 81003 7	9003414 87003 1	9003414 85003 3
	2A	180 x 236 x 222	164 x 220 x 208	173 x 229	243,7	9003414 81006 8	9003414 87006 2	9003414 85006 4
	3A	180 x 292 x 222	164 x 276 x 208	173 x 285	304,4	9003414 81009 9	9003414 87009 3	9003414 85009 5
	4A	180 x 348 x 222	164 x 332 x 208	173 x 341	335,8	9003414 81014 3	9003414 87014 7	9003414 85014 9
	1B	236 x 180 x 222	220 x 164 x 208	229 x 173	245,9	9003414 81029 7	9003414 87029 1	9003414 85029 3
	2B	236 x 236 x 222	220 x 220 x 208	229 x 229	284,7	9003414 81034 1	9003414 87034 5	9003414 85034 7
	3B	236 x 292 x 222	220 x 276 x 208	229 x 285	349,2	9003414 81040 2	9003414 87040 6	9003414 85040 8
	4B	236 x 348 x 222	220 x 332 x 208	229 x 341	392,9	9003414 81044 0	9003414 87044 4	9003414 85044 6
	1C	292 x 180 x 222	276 x 164 x 208	285 x 173	311,9	9003414 81082 2	9003414 87082 6	9003414 85082 8
	2C	292 x 236 x 222	276 x 220 x 208	285 x 229	348,7	9003414 81085 3	9003414 87085 7	9003414 85085 9
	3C	292 x 292 x 222	276 x 276 x 208	285 x 285	433,9	9003414 81089 1	9003414 87089 5	9003414 85089 7
	4C	292 x 348 x 222	276 x 332 x 208	285 x 341	474,7	9003414 81092 1	9003414 87092 5	9003414 85092 7
	1D	348 x 180 x 222	332 x 164 x 208	341 x 173	340,1	9003414 82024 1	9003414 89024 4	9003414 86024 7
	2D	348 x 236 x 222	332 x 220 x 208	341 x 229	383,5	9003414 82028 9	9003414 89028 2	9003414 86028 5
	3D	348 x 292 x 222	332 x 276 x 208	341 x 285	421,2	9003414 82031 9	9003414 89031 2	9003414 86031 5
	4D	348 x 348 x 222	332 x 332 x 208	341 x 341	515	9003414 82034 0	9003414 89034 3	9003414 86034 6
Cu usa dubla, deschidere usa: 167 x 200 cm (l x H)								
	1B	236 x 180 x 222	220 x 164 x 208	229 x 173	257,6	9003414 81060 0	9003414 87060 4	9003414 85060 6
	2B	236 x 236 x 222	220 x 220 x 208	229 x 229	296,7	9003414 81063 1	9003414 87063 5	9003414 85063 7
	3B	236 x 292 x 222	220 x 276 x 208	229 x 285	361	9003414 81069 3	9003414 87069 7	9003414 85069 9
	4B	236 x 348 x 222	220 x 332 x 208	229 x 341	400	9003414 81072 3	9003414 87072 7	9003414 85072 9
	1C	292 x 180 x 222	276 x 164 x 208	285 x 173	323,9	9003414 82005 0	9003414 89005 3	9003414 86005 6
	2C	292 x 236 x 222	276 x 220 x 208	285 x 229	360,4	9003414 82008 1	9003414 89008 4	9003414 86008 7
	3C	292 x 292 x 222	276 x 276 x 208	285 x 285	441	9003414 82011 1	9003414 89011 4	9003414 86011 7
	4C	292 x 348 x 222	276 x 332 x 208	285 x 341	485,5	9003414 82014 2	9003414 89014 5	9003414 86014 8
	1D	348 x 180 x 222	332 x 164 x 208	341 x 173	351,9	9003414 82044 9	9003414 89044 2	9003414 86044 5
	2D	348 x 236 x 222	332 x 220 x 208	341 x 229	390,5	9003414 82048 7	9003414 89048 0	9003414 86048 3
	3D	348 x 292 x 222	332 x 276 x 208	341 x 285	479,3	9003414 82051 7	9003414 89051 0	9003414 86051 3
	4D	348 x 348 x 222	332 x 332 x 208	341 x 341	526,7	9003414 82054 8	9003414 89054 1	9003414 86054 4
Accesorii aditionale								
Pergola laterala pentru modelul Neo								
	2A-2D	300 x 235 x 220			226,8	9003414 81026 6	9003414 87026 0	9003414 85026 2
	3A-3D	300 x 291 x 220			287,3	9003414 81036 5	9003414 87036 9	9003414 85036 1
	4A-4D	300 x 347 x 220			319,3	9003414 81046 4	9003414 87046 8	9003414 85046 0
Perete laterali pentru pergola laterala								
	2A-2D	203 x 4,3 x 200			65,5	9003414 81028 0	9003414 87028 4	9003414 85028 6
	3A-3D	259 x 4,3 x 200			72,2	9003414 81038 9	9003414 87038 3	9003414 85038 5
	4A-4D	315 x 4,3 x 200			89,7	9003414 81048 8	9003414 87048 2	9003414 85048 4
Perete spate pentru pergola laterala								
	2A-4D	299 x 4,3 x 200			88,6	9003414 81098 3	9003414 87098 7	9003414 85098 9
Panou de Sticla pentru pergola Laterala								
	2A-4D	31,8 x 4,2 x 200			7	9003414 47934 0	9003414 47984 5	9003414 47954 8
Flora Board pentru Acoperis Lateral								
	2A-4D	84 x 24 x 197			11,9	9003414 47036 1	9003414 47086 6	9003414 47056 9

*cel mai inalt punct, inclusiv limita acoperisului

Accesorii fundatie/Fundatie	Cod EAN	Cod EAN	Cod EAN	Cod EAN
potrivit pentru	Rama podea din aluminiu	Panou podea din aluminiu	SmartBase	SmartBase ^{PLUS}
Neo				
1A	9003414 41014 5	9003414 48014 8	9003414 43950 4	9003414 43450 9
1B, 2A	9003414 41024 4	9003414 48024 7	9003414 43954 2	9003414 43454 7
1C, 3A	9003414 41034 3	9003414 48034 6	9003414 43955 9	9003414 43455 4
1D, 4A	9003414 41044 2	9003414 48044 5	9003414 43956 6	9003414 43456 1
2B	9003414 41040 4	9003414 48040 7	9003414 43918 4	9003414 43418 9
2C, 3B	9003414 41054 1	9003414 48054 4	9003414 43960 3	9003414 43460 8
2D, 4B	9003414 41067 1	9003414 48064 3	9003414 43962 7	9003414 43462 2
3C	9003414 41074 9	9003414 48074 2	9003414 43965 8	9003414 43465 3
3D, 4C	9003414 41084 8	9003414 48084 1	9003414 43970 2	9003414 43470 7
4D	9003414 41094 7	9003414 48094 0	9003414 43974 0	9003414 43474 5

Nota: Bormasina se poate inchiria iar biti necesari sunt disponibili la Biohort

Burghiu Ø 40 x 570 mm pentru SDS-MAX, Ø 18 mm (pentru SmartBase^{PLUS})

9003414 **43410** 3

Nota: In combinatie cu usa aditionala, este necesar un pachet aditional pentru SmartBase si SmartBase^{PLUS}.

Pachet Aditional Fundatie

9003414 **43505** 6

9003414 **43405** 9

Nota: Daca rama de fixare se aseaza direct pe baza de pietris (aprox. 10 cm pietris fara fundatie) este necesara utilizarea ancorelor pentru fixare. Rezistenta la furtuna trebuie asigurata de catre client. Pentru marimile 1A, 1B, 2A, 2B 8 buc. in total, pentru marimile 1C, 3A, 1D, 4A: 10 buc. in total, pentru marimile 2C, 3B, 2D, 4B: 14 buc. in total, pentru marimile 3C, 3D, 4C, 4D: sunt necesare 16 buc. in total.

Surub de ancorare sol	4 bucati per pachet	9003414 41004 6
	6 bucati per pachet	9003414 41006 0

Fittinguri de interior		Cod EAN	Cod EAN
potrivit pentru		Panouri Interioare	Izolatie
Usa Standard	Usa Dubla		
1A		9003414 46051 5	9003414 46081 2
1B, 2A		9003414 46052 2	9003414 46082 9
	1B	9003414 46053 9	9003414 46081 2
1C, 3A		9003414 46056 0	9003414 46084 3
	1C	9003414 46057 7	9003414 46082 9
1D, 4A		9003414 46058 4	9003414 46086 7
	1D	9003414 46061 4	9003414 46084 3
2B		9003414 46054 6	9003414 46084 3
	2B	9003414 46055 3	9003414 46082 9
2C, 3B		9003414 46059 1	9003414 46086 7
	2C, 3B	9003414 46060 7	9003414 46084 3
2D, 4B		9003414 46062 1	9003414 46088 1
	2D, 4B	9003414 46064 5	9003414 46086 7
3C		9003414 46063 8	9003414 46088 1
	3C	9003414 46065 2	9003414 46086 7
3D, 4C		9003414 46066 9	9003414 46090 4
	3D, 4C	9003414 46067 6	9003414 46088 1
4D		9003414 46068 3	9003414 46093 5
	4D	9003414 46069 0	9003414 46090 4

Accesorii		Dimensiuni l x L x H (cm)	Cod EAN		
Accesorii in aceleasi culori			Argintiu Metalizat	Gri quart Metalizat	Gri Inchis Metalizat
Panou Sticla	colorat	32 x 3,3 x 207	9003414 47034 7	9003414 47084 2	9003414 47054 5
Usa aditionala		83 x 3 x 203	9003414 81002 0	9003414 87002 4	9003414 85002 6
Suport Unelte	2 bucati per pachet	30 x 5 x 3,5	9003414 47032 3	9003414 47082 8	9003414 47052 1
FloraBoard		84 x 24 x 205	9003414 47035 4	9003414 47085 9	9003414 47055 2

Accesorii		Dimensiuni l x L x H (cm)	Cod EAN
Accesorii din otel galvanizat, gri deschis			
Rafturi	2 bucati per pachet	56 x 26 x 17,3	9003414 45040 0
	4 bucati per pachet	56 x 26 x 17,3	9003414 45050 9
Cos Suspendat	2 bucati per pachet	56 x 44,5 x 17,3	9003414 45060 8
	Cu suport de perete	56 x 34 x 20	9003414 47073 6
Set Carlige	Suport unelte	56 x 23 x 10	9003414 47072 9
Agatoare unelte	2 bucati per pachet	28 x 10,4 x 17,2	9003414 47021 7
Cosuri pentru usa	2 bucati per pachet	34 x 10 x 9,5	9003414 46025 6
Cosuri pentru raft	2 bucati per pachet	72 x 16 x 11	9003414 46026 3
Prag cu rampa acces	Doar in varianta cu usa dubla si rama podea	170,5 x 9,1 x 3	9003414 41001 5
BikeLift®	Standard	33 x 184 x 28	9003414 49052 9
	Suport Pivotant	33 x 184 x 39	9003414 49053 6
Sistem agatat bicicleta BikeMax	1 bucata per pachet	14,5 x 8 x 205,5	9003414 49030 7
Sistem Fixare Bicicleta BikeHolder	set pentru 2 biciclete	56 x 17,7 x 33	9003414 49032 1
Panou montaj electric		28 x 4 x 204	9003414 46034 8
Lampa LED		44 x 4 x 1,5	9003414 46041 6



Disponibil in **doua culori si noua marimi.**
Gama completa, accesoriile si detaliile tehnice le gasiti in brosură CasaNova® brochure sau la www.biohort.com/casanova.

Brosura
CasaNova®
cerere prin
www.biohort.com

Garden Shed HighLine®, Panorama®, AvantGarde® si AvantGarde® ECO

HighLine®	Marime	Dimensiuni Exterioare*	Dimensiuni interioare	Dimensiunile fundatiei	Greutate (kg)	Cod EAN		
		l x L x HI (cm)	l x L x HI (cm)	l x L (cm)		Argintiu Metalizat	Gri cuart Metalizat	Gri Inchis Metalizat
cu usa standard, deschidere usa: 76 x 182 cm (l x H), balama deschidere pe dreapta								
	H5	155 x 275 x 222	132 x 252 x 210	137 x 257	222,8	9003414 83010 3	9003414 88010 8	9003414 84010 2
	H1	275 x 155 x 222	252 x 132 x 210	257 x 137	214,5	9003414 83020 2	9003414 88020 7	9003414 84020 1
	H2	275 x 195 x 222	252 x 172 x 210	257 x 177	232	9003414 83030 1	9003414 88030 6	9003414 84030 0
	H3	275 x 235 x 222	252 x 212 x 210	257 x 217	267,5	9003414 83040 0	9003414 88040 5	9003414 84040 9
	H4	275 x 275 x 222	252 x 252 x 210	257 x 257	283,6	9003414 83050 9	9003414 88050 4	9003414 84050 8
	H5	275 x 315 x 222	252 x 292 x 210	257 x 297	317,8	9003414 83060 8	9003414 88060 3	9003414 84060 7
H6	315 x 315 x 222	292 x 292 x 210	297 x 297	377	9003414 83070 7	9003414 88070 2	9003414 84070 6	
Cu usa dubla, deschidere usa: 155 x 182 cm (l x H)								
	H1	275 x 155 x 222	252 x 132 x 210	257 x 137	226,9	9003414 83029 5	9003414 88029 0	9003414 84029 4
	H2	275 x 195 x 222	252 x 172 x 210	257 x 177	244,4	9003414 83039 4	9003414 88039 9	9003414 84039 3
	H3	275 x 235 x 222	252 x 212 x 210	257 x 217	279,9	9003414 83049 3	9003414 88049 8	9003414 84049 2
	H4	275 x 275 x 222	252 x 252 x 210	257 x 257	296	9003414 83059 2	9003414 88059 7	9003414 84059 1
	H5	275 x 315 x 222	252 x 292 x 210	257 x 297	330,2	9003414 83069 1	9003414 88069 6	9003414 84069 0
	H6	315 x 315 x 222	292 x 292 x 210	297 x 297	389,4	9003414 83079 0	9003414 88079 5	9003414 84079 9
Accesorii aditionale								
Pergola laterala marime S pentru modelul HighLine®, latime: 150 cm								
	H2	150 x 195 x 222			75,8	9003414 83836 9	9003414 88836 4	9003414 84836 8
	H3	150 x 235 x 222			86,7	9003414 83846 8	9003414 88846 3	9003414 84846 7
	H4	150 x 275 x 222			94,2	9003414 83856 7	9003414 88856 2	9003414 84856 6
	H5, H6	150 x 315 x 222			104,1	9003414 83866 6	9003414 88866 1	9003414 84866 5
Pergola laterala marime L pentru modelul HighLine®, latime: 282 cm								
	H2	282 x 195 x 222			115	9003414 83036 3	9003414 88036 8	9003414 84036 2
	H3	282 x 235 x 222			134,6	9003414 83046 2	9003414 88046 7	9003414 84046 1
	H4	282 x 275 x 222			141,3	9003414 83056 1	9003414 88056 6	9003414 84056 0
	H5, H6	282 x 315 x 222			155,8	9003414 83066 0	9003414 88066 5	9003414 84066 9
Perete lateral pentru pergola marimile S si L								
	H2	157 x 2,5 x 181			37,8	9003414 83038 7	9003414 88038 2	9003414 84038 6
	H3	197 x 2,5 x 181			45,6	9003414 83048 6	9003414 88048 1	9003414 84048 5
	H4	237 x 2,5 x 181			54,8	9003414 83058 5	9003414 88058 0	9003414 84058 4
	H5, H6	277 x 2,5 x 181			62,8	9003414 83068 4	9003414 88068 9	9003414 84068 3
Perete spate pentru pergola marimea S. latime: 150 cm								
	S	134 x 4 x 181			33,8	9003414 83097 4	9003414 88097 9	9003414 84097 3
Perete spate pentru pergola marimea L. latime: 282 cm								
	L	266 x 4 x 181			61,2	9003414 83098 1	9003414 88098 6	9003414 84098 0
Panorama®								
cu usa standard, deschidere usa: 76 x 182 cm (l x H), balama deschidere pe dreapta								
	P1	273 x 158 x 227	252 x 132 x 220	257 x 137	202,2	9003414 13020 3	9003414 18020 8	9003414 14020 2
	P2	273 x 198 x 227	252 x 172 x 220	257 x 177	225,7	9003414 13030 2	9003414 18030 7	9003414 14030 1
	P3	273 x 238 x 227	252 x 212 x 220	257 x 217	250	9003414 13040 1	9003414 18040 6	9003414 14040 0
	P4	273 x 278 x 227	252 x 252 x 220	257 x 257	271,9	9003414 13050 0	9003414 18050 5	9003414 14050 9
	P5	273 x 318 x 227	252 x 292 x 220	257 x 297	293,9	9003414 13060 9	9003414 18060 4	9003414 14060 8
Cu usa dubla, deschidere usa: 155 x 182 cm (l x H)								
	P1	273 x 158 x 227	252 x 132 x 220	257 x 137	214,6	9003414 13029 6	9003414 18029 1	9003414 14029 5
	P2	273 x 198 x 227	252 x 172 x 220	257 x 177	238,1	9003414 13039 5	9003414 18039 0	9003414 14039 4
	P3	273 x 238 x 227	252 x 212 x 220	257 x 217	262,4	9003414 13049 4	9003414 18049 9	9003414 14049 3
	P4	273 x 278 x 227	252 x 252 x 220	257 x 257	284,3	9003414 13059 3	9003414 18059 8	9003414 14059 2
	P5	273 x 318 x 227	252 x 292 x 220	257 x 297	306,3	9003414 13069 2	9003414 18069 7	9003414 14069 1

*cel mai inalt punct, inclusiv limita acoperisului

AvantGarde®	Marime	Dimensiuni Exterioare*	Dimensiuni interioare	Dimensiunile fundatiei	Greutate (kg)	Cod EAN		
		l x L x Hl (cm)	l x L x Hl (cm)	l x L (cm)		Argintiu Metalizat	Gri cuart Metalizat	Gri Inchis Metalizat
cu usa standard, deschidere usa: 76 x 182 cm (l x H), balama deschidere pe dreapta								
	A1	180 x 220 x 218	172 x 172 x 209	177 x 177	155,8	9003414 15010 2	9003414 19010 8	9003414 17010 0
	A2	180 x 260 x 218	172 x 212 x 209	177 x 217	175,7	9003414 15020 1	9003414 19020 7	9003414 17020 9
	A3	180 x 300 x 218	172 x 252 x 209	177 x 257	194,2	9003414 15030 0	9003414 19030 6	9003414 17030 8
	A4	180 x 380 x 222	172 x 332 x 209	177 x 337	237,3	9003414 15040 9	9003414 19040 5	9003414 17040 7
	A5	260 x 220 x 218	252 x 172 x 209	257 x 177	191	9003414 15050 8	9003414 19050 4	9003414 17050 6
	A6	260 x 260 x 218	252 x 212 x 209	257 x 217	214,5	9003414 15060 7	9003414 19060 3	9003414 17060 5
	A7	260 x 300 x 218	252 x 252 x 209	257 x 257	230,8	9003414 15070 6	9003414 19070 2	9003414 17070 4
	A8	260 x 380 x 222	252 x 332 x 209	257 x 337	281,5	9003414 15080 5	9003414 19080 1	9003414 17080 3
Cu usa dubla, deschidere usa: A1 - A4: 139 x 182 cm (l x H) A5 - A8: 155 x 182 cm (l x H)								
A1	180 x 220 x 218	172 x 172 x 209	177 x 177	167	9003414 15019 5	9003414 19019 1	9003414 17019 3	
A2	180 x 260 x 218	172 x 212 x 209	177 x 217	186,9	9003414 15029 4	9003414 19029 0	9003414 17029 2	
A3	180 x 300 x 218	172 x 252 x 209	177 x 257	202,4	9003414 15039 3	9003414 19039 9	9003414 17039 1	
A4	180 x 380 x 222	172 x 332 x 209	177 x 337	247	9003414 15049 2	9003414 19049 8	9003414 17049 0	
A5	260 x 220 x 218	252 x 172 x 209	257 x 177	203,4	9003414 15059 1	9003414 19059 7	9003414 17059 9	
A6	260 x 260 x 218	252 x 212 x 209	257 x 217	226,9	9003414 15069 0	9003414 19069 6	9003414 17069 8	
A7	260 x 300 x 218	252 x 252 x 209	257 x 257	243,2	9003414 15079 9	9003414 19079 5	9003414 17079 7	
A8	260 x 380 x 222	252 x 332 x 209	257 x 337	293,9	9003414 15089 8	9003414 19089 4	9003414 17089 6	

AvantGarde®ECO	Marime	Dimensiuni Exterioare*	Dimensiuni interioare	Dimensiunile fundatiei	Greutate (kg)	Cod EAN		
		l x L x Hl (cm)	l x L x Hl (cm)	l x L (cm)		Argintiu Metalizat	Gri cuart Metalizat	Gri Inchis Metalizat
cu usa standard, deschidere usa: 76 x 182 cm (l x H), balama deschidere pe dreapta								
	A1	180 x 220 x 218	172 x 172 x 209	177 x 177	128	9003414 15610 4	9003414 19610 0	9003414 17610 2
	A2	180 x 260 x 218	172 x 212 x 209	177 x 217	146	9003414 15620 3	9003414 19620 9	9003414 17620 1
	A3	180 x 300 x 218	172 x 252 x 209	177 x 257	161	9003414 15630 2	9003414 19630 8	9003414 17630 0
	A4	180 x 380 x 222	172 x 332 x 209	177 x 337	204	9003414 15640 1	9003414 19640 7	9003414 17640 9
	A5	260 x 220 x 218	252 x 172 x 209	257 x 177	160	9003414 15650 0	9003414 19650 6	9003414 17650 8
	A6	260 x 260 x 218	252 x 212 x 209	257 x 217	182	9003414 15660 9	9003414 19660 5	9003414 17660 7
	A7	260 x 300 x 218	252 x 252 x 209	257 x 257	194	9003414 15670 8	9003414 19670 4	9003414 17670 6
	A8	260 x 380 x 222	252 x 332 x 209	257 x 337	246	9003414 15680 7	9003414 19680 3	9003414 17680 5
Cu usa dubla, deschidere usa: A1 - A4: 139 x 182 cm (l x H) A5 - A8: 155 x 182 cm (l x H)								
A1	180 x 220 x 218	172 x 172 x 209	177 x 177	133	9003414 15619 7	9003414 19619 3	9003414 17619 5	
A2	180 x 260 x 218	172 x 212 x 209	177 x 217	151	9003414 15629 6	9003414 19629 2	9003414 17629 4	
A3	180 x 300 x 218	172 x 252 x 209	177 x 257	166	9003414 15639 5	9003414 19639 1	9003414 17639 3	
A4	180 x 380 x 222	172 x 332 x 209	177 x 337	215	9003414 15649 4	9003414 19649 0	9003414 17649 2	
A5	260 x 220 x 218	252 x 172 x 209	257 x 177	163	9003414 15659 3	9003414 19659 9	9003414 17659 1	
A6	260 x 260 x 218	252 x 212 x 209	257 x 217	185	9003414 15669 2	9003414 19669 8	9003414 17669 0	
A7	260 x 300 x 218	252 x 252 x 209	257 x 257	197	9003414 15679 1	9003414 19679 7	9003414 17679 9	
A8	260 x 380 x 222	252 x 332 x 209	257 x 337	249	9003414 15689 0	9003414 19689 6	9003414 17689 8	

*cel mai inalt punct, inclusiv limita acoperisului

Accesorii fundatie / Fundatie			Cod EAN	Cod EAN	Cod EAN	Cod EAN
potrivit pentru			Rama podea din aluminiu	Panou podea din aluminiu	SmartBase	SmartBase ^{PLUS}
HighLine®	Panorama®	AvantGarde®				
		AvantGarde®ECO				
		A1	9003414 41031 2	9003414 48031 5	9003414 43946 7	9003414 43446 2
		A2	9003414 41071 8	9003414 48071 1	9003414 43988 7	9003414 43488 2
H1, HS	P1		9003414 41022 0	9003414 48022 3	9003414 43952 8	9003414 43452 3
H2	P2	A3, A5	9003414 41041 1	9003414 48041 4	9003414 43958 0	9003414 43458 5
		A4	9003414 41081 7	9003414 48081 0	9003414 43976 4	9003414 43476 9
H3	P3	A6	9003414 41042 8	9003414 48042 1	9003414 43963 4	9003414 43463 9
H4	P4	A7	9003414 41051 0	9003414 48051 3	9003414 43968 9	9003414 43468 4
H5	P5		9003414 41062 6	9003414 48062 9	9003414 43973 3	9003414 43473 8
		A8	9003414 41061 9	9003414 48061 2	9003414 43978 8	9003414 43478 3
H6			9003414 41043 5	9003414 48043 8	9003414 43995 5	9003414 43495 0

Nota: Bormasina se poate inchiria iar biti necesari sunt disponibili la Biohort

Burghiu Ø 40 x 570 mm pentru SDS-MAX Ø 18 mm (pentru SmartBase^{PLUS}) 9003414 43410 3





Nota: In combinatie cu usa aditionala, este necesar un pachet aditional pentru SmartBase si SmartBase^{PLUS}.

Pachet Adicional Fundatie 9003414 43505 6 9003414 43405 9



Nota: Daca rama de fixare se aseaza direct pe baza de pietris (aprox. 10 cm pietris fara fundatie) este necesara utilizarea ancorelor pentru fixare. Rezistenta la furtuna trebuie asigurata de catre client. Pentru marimea A1, HS, H1, P1: 8 buc. in total, pentru marimile H2, P2, A2, H3, P3, A3, A4, A5, A6: 10 buc. in total, pentru marimile H4, P4, H5, P5, H6 A7, A8: sunt necesare 12 buc. in total.

Surub de ancorare sol 4 bucati per pachet 9003414 41004 6

6 bucati per pachet 9003414 41006 0

Accesorii		Dimensiuni l x L x l (cm) / Culoare				
Accesorii in aceleasi culori			HighLine®	Panorama®	AvantGarde®	AvantGarde®ECO
Usa aditionala	Cu clanta din otel inoxidabil si arc cu amortizor pe gaz	Argintiu Metalizat	9003414 83002 8	9003414 83002 8	9003414 83002 8	-
		Gri cuart Metalizat	9003414 88002 3	9003414 88002 3	9003414 88002 3	-
		Gri Inchis Metalizat	9003414 84002 7	9003414 84002 7	9003414 84002 7	-
Usa aditionala ECO	Cu striatii, cu maner in T si carlige la usa	Argintiu Metalizat	-	-	-	9003414 83602 0
		Gri cuart Metalizat	-	-	-	9003414 88602 5
		Gri Inchis Metalizat	-	-	-	9003414 84602 9
Fereastră		Argintiu Metalizat	9003414 43065 5	9003414 43065 5	9003414 43065 5	9003414 43065 5
		Gri cuart Metalizat	9003414 43085 3	9003414 43085 3	9003414 43085 3	9003414 43085 3
		Gri Inchis Metalizat	9003414 43055 6	9003414 43055 6	9003414 43055 6	9003414 43055 6
Set Jgheab		Argintiu Metalizat	9003414 44025 8	9003414 44024 1	9003414 44022 7	9003414 44022 7
		Gri cuart Metalizat	9003414 44085 2	9003414 44084 5	9003414 44082 1	9003414 44082 1
		Gri Inchis Metalizat	9003414 44065 4	9003414 44064 7	9003414 44062 3	9003414 44062 3
FloraBoard		Argintiu Metalizat	9003414 47030 9	9003414 47030 9	9003414 47030 9	9003414 47030 9
		Gri cuart Metalizat	9003414 47080 4	9003414 47080 4	9003414 47080 4	9003414 47080 4
		Gri Inchis Metalizat	9003414 47050 7	9003414 47050 7	9003414 47050 7	9003414 47050 7
Suport unelte	2 bucati per pachet	Argintiu Metalizat	9003414 47031 6	9003414 47031 6	9003414 47031 6	-
		Gri cuart Metalizat	9003414 47081 1	9003414 47081 1	9003414 47081 1	-
		Gri Inchis Metalizat	9003414 47051 4	9003414 47051 4	9003414 47051 4	-
Suport unelte ECO	2 bucati per pachet pentru usi ECO	Argintiu Metalizat	-	-	-	9003414 47032 3
		Gri cuart Metalizat	-	-	-	9003414 47082 8
		Gri Inchis Metalizat	-	-	-	9003414 47052 1
Facut din placa de otel galvanizat la cald cu protectie poliamida.						
Sine suport rafturi	2 bucati per pachet	4 x 4 x 185	9003414 46021 8	9003414 46021 8	9003414 46021 8	9003414 46021 8
Rafturi	2 bucati per pachet	72 x 24,5 x 7	9003414 45010 3	9003414 45010 3	9003414 45010 3	9003414 45010 3
	4 bucati per pachet	72 x 24,5 x 7	9003414 45020 2	9003414 45020 2	9003414 45020 2	9003414 45020 2
	2 bucati per pachet	72 x 43,5 x 7	9003414 45030 1	9003414 45030 1	9003414 45030 1	9003414 45030 1
Masa plianta		69,2 x 57,5 x 40	9003414 40011 5	9003414 40011 5	9003414 40011 5	9003414 40011 5
Cos Suspendat	Cu suport de perete	67 x 34 x 20	9003414 47071 2	9003414 47071 2	9003414 47071 2	9003414 47071 2
Set Carlige	Suport unelte	72 x 17 x 73	9003414 47070 5	9003414 47070 5	9003414 47070 5	9003414 47070 5
Agatoare unelte	4 bucati per pachet	13 x 9,5 x 30	9003414 47020 0	9003414 47020 0	9003414 47020 0	9003414 47020 0
Cosuri pentru usa	2 bucati per pachet	34 x 10 x 9,5	9003414 46025 6	9003414 46025 6	9003414 46025 6	9003414 46025 6
Cosuri pentru raft	2 bucati per pachet	72 x 16 x 11	9003414 46026 3	9003414 46026 3	9003414 46026 3	9003414 46026 3
Prag cu rampa acces	Doar in varianta cu usa dubla si rama podea	135 x 14,5 x 7	9003414 41000 8	9003414 41000 8	9003414 41000 8	9003414 41000 8
BikeLift®	Standard	33 x 184 x 27,5	9003414 49050 5	9003414 49050 5	9003414 49050 5	9003414 49050 5
	Suport Pivotant	33 x 184 x 38,5	9003414 49051 2	9003414 49051 2	9003414 49051 2	9003414 49051 2
Sistem agatat bicicleta BikeMax	1 bucata per pachet		9003414 49011 6	9003414 49011 6	9003414 49011 6	9003414 49011 6
	2 bucati per pachet	4 x 4 x 185	9003414 49021 5	9003414 49021 5	9003414 49021 5	9003414 49021 5
Sistem Fixare Bicicleta BikeHolder	set pentru 3 biciclete	72 x 10 x 33	9003414 49012 3	9003414 49012 3	9003414 49012 3	9003414 49012 3
Panou montaj electric		20 x 4 x 185	9003414 46031 7	9003414 46031 7	9003414 46031 7	9003414 46031 7
Lampa LED		44 x 4 x 1,5	9003414 46041 6	9003414 46041 6	9003414 46041 6	9003414 46041 6
Arcurile cu amortizor, pe gaz sunt dotare standard! Exceptii: AvantGarde®ECO si usa aditionala ECO						
Arc cu amortizor pe gaz pentru usi ECO	1 bucata per pachet	34 x 2 x 2	-	-	-	9003414 83608 2
	2 bucati per pachet	34 x 2 x 2	-	-	-	9003414 83609 9

Accesorii Model Europa si Equipment Locker

Europa	Marime	Dimensiuni Exterioare*	Dimensiuni interioare	Dimensiunile fundatiei	Greutate	Cod EAN				
		l x L x Hl (cm)	l x L x Hl (cm)	l x L (cm)	(kg)	Argintiu Metalizat	Gri cuart Metalizat	Gri Inchis Metalizat	Verde inchis	
Deschidere usa: 135 x 170 cm (l x H)										
	1	172 x 84 x 196	150 x 78 x 188	155 x 83	90,4	9003414 29010 5	9003414 22010 2	9003414 24010 0	9003414 23010 1	
	2	172 x 156 x 196	150 x 150 x 188	155 x 155	115,2	9003414 29020 4	9003414 22020 1	9003414 24020 9	9003414 23020 0	
	3	244 x 156 x 203	222 x 150 x 195	227 x 155	139,4	9003414 29030 3	9003414 22030 0	9003414 24030 8	9003414 23030 9	
	4	244 x 228 x 203	222 x 222 x 195	227 x 227	167,8	9003414 29040 2	9003414 22040 9	9003414 24040 7	9003414 23040 8	
	5	316 x 228 x 209	294 x 222 x 202	299 x 227	202,6	9003414 29050 1	9003414 22050 8	9003414 24050 6	9003414 23050 7	
	6	244 x 300 x 203	222 x 294 x 195	227 x 299	197,8	9003414 29060 0	9003414 22060 7	9003414 24060 5	9003414 23060 6	
	7	316 x 300 x 209	294 x 294 x 202	299 x 299	233,9	9003414 29070 9	9003414 22070 6	9003414 24070 4	9003414 23070 5	
	2A	244 x 84 x 203	222 x 78 x 195	227 x 83	112,2	9003414 29080 8	9003414 22080 5	9003414 24080 3	9003414 23080 4	
	4A	316 x 156 x 209	294 x 150 x 202	299 x 155	165,1	9003414 29090 7	9003414 22090 4	9003414 24090 2	9003414 23090 3	
	Accesorii aditionale	Pergola laterala pentru modelul Europa								
	2,3,4A	150 x 156 x 170			21,7	9003414 42019 9	9003414 42012 0	9003414 42014 4	9003414 42040 3	
	4, 5	150 x 228 x 170			27,5	9003414 42029 8	9003414 42022 9	9003414 42024 3	9003414 42050 2	
	6, 7	150 x 300 x 170			35,2	9003414 42039 7	9003414 42032 8	9003414 42034 2	9003414 42060 1	

*cel mai inalt punct, inclusiv limita acoperisului

Equipment Locker	Marime	Dimensiuni Exterioare*	Dimensiuni interioare	Dimensiunile fundatiei	Greutate	Cod EAN		
		l x L x Hl (cm)	l x L x Hl (cm)	l x L (cm)	(kg)	Argintiu Metalizat	Gri quart Metalizat	Gri Inchis Metalizat
Deschidere usa: Marime 90: 65 x 170 cm (l x H), de la marimea 150: 135 x 170 cm (l x H)								
	90	93 x 83 x 182,5	88 x 78 x 177	93 x 83	56,4	9003414 34030 5	9003414 30030 9	9003414 31030 8
	150	155 x 83 x 182,5	150 x 78 x 177	155 x 83	88,1	9003414 34010 7	9003414 30010 1	9003414 31010 0
	150 ^{LARGE}	156 x 155 x 184	150 x 150 x 177	155 x 155	ca. 110,2	9003414 34910 0	9003414 30910 4	9003414 31910 3
	190	191 x 83 x 182,5	186 x 78 x 177	191 x 83	101,4	9003414 34060 2	9003414 30060 6	9003414 31060 5
	190 ^{LARGE}	192 x 155 x 184	186 x 150 x 177	191 x 155	ca. 124,1	9003414 34960 5	9003414 30960 9	9003414 31960 8
	230	227 x 83 x 182,5	222 x 78 x 177	227 x 83	109,9	9003414 34080 0	9003414 30080 4	9003414 31080 3
	230 ^{LARGE}	228 x 155 x 184	222 x 150 x 177	227 x 155	ca. 133,7	9003414 34980 3	9003414 30980 7	9003414 31980 6

cel mai inalt punct, inclusiv limita acoperisului

Accesorii fundatie/Fundatie potrivit pentru		Cod EAN	Cod EAN	Cod EAN	Cod EAN
Europa	Equipment Locker	Rama podea din aluminiu	Panou podea din aluminiu	SmartBase	SmartBase ^{PLUS}
	90				
	90	9003414 41011 4	9003414 48011 7	9003414 43982 5	9003414 43482 0
1	150	9003414 41010 7	9003414 48010 0	9003414 43901 6	9003414 43401 1
2	150 ^{LARGE}	9003414 41020 6	9003414 48020 9	9003414 43906 1	9003414 43406 6
	190	9003414 41012 1	9003414 48012 4	9003414 43929 0	9003414 43426 4
	190 ^{LARGE}	9003414 41015 2	9003414 48015 5	9003414 43910 8	9003414 43510 0
2A	230	9003414 41080 0	9003414 48080 3	9003414 43936 8	9003414 43436 3
3	230 ^{LARGE}	9003414 41030 5	9003414 48030 8	9003414 43912 2	9003414 43412 7
4		9003414 41040 4	9003414 48040 7	9003414 43918 4	9003414 43418 9
4A		9003414 41090 9	9003414 48090 2	9003414 43942 9	9003414 43442 4
5, 6		9003414 41050 3	9003414 48050 6	9003414 43923 8	9003414 43423 3
7		9003414 41070 1	9003414 48070 4	9003414 43930 6	9003414 43430 1

Nota: Bormasina se poate inchiria iar biti necesari sunt disponibili la Biohort

Burghiu Ø 40 x 570 mm pentru SDS-MAX Ø 18 mm (pentru SmartBase ^{PLUS})	9003414 43410 3
Nota: Daca rama de fixare se aseaza direct pe baza de pietris (aprox. 10 cm pietris fara fundatie) este necesara utilizarea ancorelor pentru fixare. Rezistenta la furtuna trebuie asigurata de catre client. pentru marimile 1,90,150: 4 buc.in total ; pentru marimile 2, 2A 150 ^{MARE} , 190, 190 ^{MARE} , 230: 6 buc. in total; pentru marimile 3, 4, 4A, 230 ^{MARE} : 8 buc. in total, pentru marimile 5, 6, 7: sunt necesare 10 buc. in total.	
Surub de ancorare sol	4 bucati per pachet 9003414 41004 6 6 bucati per pachet 9003414 41006 0

Accesorii	Dimensiuni l x L x l (cm) / Culoare		
Accesorii in aceleasi culori			
Usa additionala Usadubla	Cu striatii, cu maner in T si carlige la usa	Argintiu Metalizat	9003414 29001 3
		Gri quart Metalizat	9003414 22001 0
		Gri Inchis Metalizat	9003414 24001 8
		Verde inchis	9003414 23001 9
Set burlane	Argintiu Metalizat	9003414 44070 8	-
	Gri quart Metalizat	9003414 44080 7	-
	Gri Inchis Metalizat	9003414 44050 0	-
Fereastră	Verde inchis	9003414 44040 1	-
	Argintiu Metalizat	9003414 43060 0	-
	Gri quart Metalizat	9003414 43080 8	-
	Gri Inchis Metalizat	9003414 43050 1	-
	Verde inchis	9003414 43040 2	-

Placa otel galvanizata la cald cu protectie poliaramida

Sine suport rafturi	2 bucati per pachet	4 x 4 x 173	9003414 46020 1	9003414 46020 1
Rafturi	2 bucati per pachet	72 x 24,5 x 7	9003414 45010 3	9003414 45010 3
	4 bucati per pachet	72 x 24,5 x 7	9003414 45020 2	9003414 45020 2
	2 bucati per pachet	72 x 43,5 x 7	9003414 45030 1	9003414 45030 1
Masa plianta		69,2 x 57,5 x 40	9003414 40011 5	9003414 40011 5
Cos Suspendat	Cu suport de perete	67 x 34 x 20	9003414 47071 2	9003414 47071 2
Set Carlige	Suport unelte	72 x 17 x 73	9003414 47070 5	9003414 47070 5
Agatoare unelte	4 bucati per pachet	13 x 9,5 x 30	9003414 47020 0	9003414 47020 0
Cosuri pentru usa	2 bucati per pachet	34 x 10 x 9,5	9003414 46025 6	9003414 46025 6
Cosuri pentru raft	2 bucati per pachet	72 x 16 x 11	9003414 46026 3	9003414 46026 3
Panou montaj electric		28 x 6 x 172,5	9003414 46030 0	9003414 46030 0
Lampa LED		44 x 4 x 1,5	9003414 46041 6	9003414 46041 6
Prag cu rampa acces	Doar in varianta cu usa dubla si rama podea	135 x 14,5 x 7	9003414 41000 8	-
	Standard	33 x 184 x 27,5	9003414 49050 5	-
BikeLift®	Suport Pivotant – Se poate asambla doar central pe peretele din spate	33 x 184 x 38,5	9003414 49051 2	-
Sistem agatat bicicleta BikeMax	1 bucata per pachet		9003414 49010 9	-
	2 bucati per pachet	4 x 4 x 173	9003414 49020 8	-
Sistem Fixare Bicicleta BikeHolder	set pentru 3 biciclete	72 x 10 x 33	9003414 49012 3	-

Cutii Outdoor · Depozitare biciclete · Depozitare pubela

Romeo®	Marime	Dimensiuni Exterioare	Dimensiuni interioare	Volum	Greutate	Cod EAN		
		l x L x HI (cm)	l x L x HI (cm)	(L)	(kg)	Argintiu Metalizat	Gri cuart Metalizat	Gri Inchis Metalizat
	M	132 x 57 x 140	127 x 46 x 135	800	68,1	9003414 55070 4	9003414 58070 1	9003414 56070 3
	L	132 x 87 x 140	127 x 76 x 135	1300	81,9	9003414 55080 3	9003414 58080 0	9003414 56080 2
Accesorii		Pentru marimea		Dimensiuni l x L x H (cm)		Cod EAN		
Rafturi		M, L		61 x 43 x 40 (2-parti)		9003414 75055 5		

StoreMax®	Marime	Dimensiuni Exterioare	Dimensiuni interioare	Volum	Greutate	Cod EAN		
		l x L x HI (cm)	l x L (cm)	(L)	(kg)	Argintiu Metalizat	Gri cuart Metalizat	Gri Inchis Metalizat
	120	117 x 73 x 109	114 x 62	740	48,2	9003414 72060 2	9003414 70060 4	9003414 73060 1
	160	163 x 78 x 120	160 x 67	1200	65,1	9003414 72010 7	9003414 70010 9	9003414 73010 6
	190	190 x 97 x 136	188 x 86	2080	88,8	9003414 72020 6	9003414 70020 8	9003414 73020 5
Accesorii		Pentru marimea		Dimensiuni l x L x H (cm)		Cod EAN		
Set rafturi pe colt (triunghiular)		120, 160		54 x 54 x 53,5		9003414 74010 5		
Raft Intermediar		160		160 (2 x 80) x 59,5 x 53,5		9003414 75010 4		
		190		187 (2 x 93,5) x 74,5 x 53,5		9003414 75020 3		
Set rafturi		190		72 x 24,5 x 53,5		9003414 74020 4		
Sistem Fixare Bicicleta BikeHolder		190		72 x 15 x 33		9003414 74030 3		

HighBoard	Marime	Dimensiuni Exterioare	Dimensiuni interioare	Volum	Greutate	Cod EAN		
		l x L x HI (cm)	l x L x HI (cm)	(L)	(kg)	Argintiu Metalizat	Gri cuart Metalizat	Gri Inchis Metalizat
	160	160,5 x 70,5 x 118	156 x 62 x 113	1150	82,7	9003414 72015 2	9003414 70015 4	9003414 73015 1
	200	200,5 x 84,5 x 127	195 x 76 x 120	2150	114,5	9003414 72025 1	9003414 70025 3	9003414 73025 0
Accesorii		Pentru marimea		Dimensiuni l x L x H (cm)		Cod EAN		
Suport Unelte		160, 200		51,6 x 3,5 x 5		9003414 47031 6	9003414 47081 1	9003414 47051 4
Plasa depozitare la capac		160, 200		25 x 67 x 2		9003414 67010 5		
Raft Intermediar		160		78 x 30 x 53,5 per raft (4 piese)		9003414 75015 9		
		200		97 x 74 x 53,5 per raft (2 piese)		9003414 75025 8		
Cos suspendat, tip B		160		54,5 x 50 x 20		9003414 67071 6		
Cos suspendat, tip C		200		68,5 x 67 x 20		9003414 67072 3		
Sistem Fixare Bicicleta BikeHolder		200		72 x 10 x 33		9003414 49012 3		
Panou montaj electric		200		58 x 2 x 23		9003414 46032 4		

LoungeBox®	Marime	Dimensiuni Exterioare	Dimensiuni interioare	Volum	Greutate	Cod EAN		
		l x L x HI (cm)	l x L x HI (cm)	(L)	(kg)	Argintiu Metalizat	Gri cuart Metalizat	Gri Inchis Metalizat
	160	160 x 70 x 83,5	159 x 66 x 77	850	50,1	9003414 64065 8	9003414 68065 4	9003414 65065 7
	200	200 x 85 x 90	199 x 80 x 81	1400	71,9	9003414 64075 7	9003414 68075 3	9003414 65075 6
Accesorii		Pentru marimea		Dimensiuni l x L x H (cm)		Cod EAN		
Plasa depozitare la capac		pentru toate marimile		25 x 67 x 2		9003414 67010 5		
Cos suspendat, tip B		160		54,5 x 50 x 20		9003414 67071 6		
Cos suspendat, tip C		200		68,5 x 67 x 20		9003414 67072 3		

StyleBox®	Marime	Dimensiuni Exterioare	Dimensiuni interioare	Volum	Greutate	Cod EAN		
		l x L x HI (cm)	l x L x HI (cm)	(L)	(kg)	Argintiu Metalizat	Gri cuart Metalizat	Gri Inchis Metalizat
	140	140 x 60 x 71	129 x 49 x 63	400	42,8	9003414 19830 2	9003414 19832 6	9003414 19831 9
	170	170 x 70 x 81	159 x 59 x 73	685	57,7	9003414 19833 3	9003414 19835 7	9003414 19834 0
	210	207 x 80 x 81	196 x 69 x 73	990	73,4	9003414 19836 4	9003414 19838 8	9003414 19837 1
Accesorii		Pentru marimea		Dimensiuni l x L x H (cm)		Cod EAN		
Plasa depozitare la capac		pentru toate marimile		25 x 67 x 2		9003414 67010 5		
Cos suspendat, tip D		140		48,5 x 50,5 x 20		9003414 67073 0		
Cos suspendat, tip E		170		59 x 50,5 x 20		9003414 67074 7		
Cos suspendat, tip C		210		68,5 x 67 x 20		9003414 67072 3		
Roti		pentru toate marimile		4,5 x 3,5 x 3,5		9003414 67030 3		

LeisureTime Box	Marime	Dimensiuni Exterioare	Dimensiuni interioare	Volum	Greutate	Cod EAN				
		I x L x HI (cm)	I x L x HI (cm)	(L)	(kg)	Alb	Argintiu Metalizat	Met. Gri quart	Met. Gri Inchis	Bronz metalic
	100	101 x 46 x 61	92 x 37,5 x 56	195	19,4	9003414 61010 1	9003414 64010 8	9003414 68010 4	9003414 65010 7	9003414 62010 0
	130	134 x 62 x 71	125 x 53,5 x 66	460	31,5	9003414 61040 8	9003414 64040 5	9003414 68040 1	9003414 65040 4	9003414 62040 7
	160 ^{HIGH}	160 x 79 x 83	151 x 70,5 x 78	830	47,5	9003414 61060 6	9003414 64060 3	9003414 68060 9	9003414 65060 2	9003414 62060 5
	180	181 x 79 x 71	172 x 70,5 x 66	800	47,7	9003414 61030 9	9003414 64030 6	9003414 68030 2	9003414 65030 5	9003414 62030 8
	200	201 x 79 x 83	192 x 70,5 x 77,5	1050	62,3	9003414 61090 3	9003414 64090 0	9003414 68090 6	9003414 65090 9	9003414 62090 2
Accesorii		Pentru marimea		Dimensiuni (cm)		Cod EAN				
Plasa depozitare la capac		pentru toate marimile		25 x 67 x 2		9003414 67010 5				
Cos suspendat, tip A		100, 160, 180, 200		67 x 34 x 20		9003414 67070 9				
Cos suspendat, tip B		130		54,5 x 50 x 20		9003414 67071 6				
Cos suspendat, tip C		160, 180, 200		68,5 x 67 x 20		9003414 67072 3				
Kit cutie colet		pentru toate marimile		16,5 x 26,5 x 5		9003414 67020 4				

Cutie Colet	Marime	Dimensiuni Exterioare	Dimensiuni interioare	Volum	Greutate	Cod EAN				
		I x L x HI (cm)	I x L x HI (cm)	(L)	(kg)	Alb	Argintiu Metalizat	Met. Gri quart	Met. Gri Inchis	Met. Bronz
	100	101 x 46 x 61	92 x 37,5 x 56	195	19,9	9003414 61910 4	9003414 64910 1	9003414 68910 7	9003414 65910 0	9003414 62910 3

MiniGarage	Marime	Dimensiuni Exterioare	Dimensiuni interioare	Dimensiunile fundatiei	Greutate	Cod EAN	
		I x L x HI (cm)	I x L x HI (cm)	I x L (cm)	(kg)	Argintiu Metalizat	Gri Inchis Metalizat
	L	145 x 203 x 150	140 x 195 x 143,5	145 x 203	109,4	9003414 55040 7	9003414 56040 6
Accesorii		Dimensiuni I x L x H (cm)			Cod EAN		
Rama podea din aluminiu*		140 x 198 x 4			9003414 41032 9		
Surub de ancorare sol**		4 bucati per pachet (8 bucati sunt necesare in total)			9003414 41004 6		
Panou podea din aluminiu*		131,6 x 189,7 x 0,2			9003414 48032 2		
SmartBase*		140 x 198 x 18			9003414 43938 2		
SmartBase ^{PLUS} *		140 x 198 x 65			9003414 43439 4		
Set rafturi*		77 x 26,8 x 14 per raft, inclusiv suportul ed rafturi			9003414 45013 4		
Sina pentru bicicleta*		17,9 x 199,9 x 139,5			9003414 49014 7		
Panou montaj electric*		72 x 2,1 x 28			9003414 46039 3		
Lampa LED		44 x 4 x 1,5			9003414 46041 6		

*Nota:marimea MiniGarage s-a schimbat Accesoriile se potrivesc doar cu "Modelul 2023 / Size L" cu dimensiunile 145 x 203 x 150 cm. Va rugam sa verificati cu atentie ca aveti dimensiunile potrivite pentru a putea folosi accesoriile.

**Daca rama de podea este asezata direct pe o baza de pietris (aprox. 10 cm de pietris fara fundatie sau dale), sunt necesare suruburile de ancorare pentru fixarea in sol. Rezistenta la furtuna trebuie asigurata de catre client.

Alex®	Dimensiuni Exterioare	Dimensiuni interioare	Volum	Greutate	Cod EAN		
	I x L x HI (cm)	I x L x HI (cm)	(L)	(kg)	Argintiu Metalizat	Gri quart Metalizat	Gri Inchis Metalizat
	80 x 88 x 129	74,4 x 80 x 124,7	740	53,7	9003414 53063 8	9003414 58068 8	9003414 54064 4
La comanda a 3 sau mai multe cutii depozitare pubele Dustbin Box Alex® se accorda un discount.							
Balama pe stanga					9003414 59065 6	9003414 59065 6	9003414 59065 6
Accesorii					Argintiu Metalizat	Gri quart Metalizat	Gri Inchis Metalizat
Element de legatura		Pentru 2 unitati Alex® (un element de legatura)			9003414 53067 6	9003414 58067 1	9003414 54067 5
		Pentru 3 unitati Alex® (doua elemente de legatura)			9003414 53069 0	9003414 58069 5	9003414 54069 9
Incuetoarcilindrica potrivita		Pentru 2 unitati Alex®			9003414 50040 2	9003414 50040 2	9003414 50040 2
		Pentru 3 unitati Alex®			9003414 50041 9	9003414 50041 9	9003414 50041 9
Rafturi		72 x 43,5 x 7			9003414 45030 1	9003414 45030 1	9003414 45030 1
Sine suport rafturi		122 x 3 x 3			9003414 46022 5	9003414 46022 5	9003414 46022 5

BikeLift® pentru montare pe perete

BikeLift®	Varianta	Dimensiuni Exterioare	Greutate	Cod EAN	
		I x L x HI (cm)	(kg)	Gri Inchis Metalizat	
	Standard	16 x 38 x 180	9,5	9003414 49054 3	
	Support Pivotant	16 x 53 x 182	13	9003414 49055 0	
Accesorii		Cod EAN			
Panou montaj electric pentru priza		se poate combina cu toate variantele	10 x 12 x 4	0,2	9003414 49059 8

Se potrivește cu aproape orice bicicleta. Verifica bicicleta: www.biohort.com/bikelift

Rasadnita

Rasadnita	Marime	Dimensiuni Exterioare	Dimensiuni interioare	Volum	Greutate	Cod EAN		
		l x L x Hl (cm)	l x L x Hl (cm)	(L)	(kg)	Argintiu Metalizat	Gri cuart Metalizat	Gri Inchis Metalizat
	1 x 0,5	102 x 53 x 77	95 x 46 x 77	340	34,6	9003414 64012 2	9003414 68012 8	9003414 65012 1
	1 x 1	102 x 102 x 77	95 x 95 x 77	695	43,2	9003414 64005 4	9003414 68005 0	9003414 65005 3
	1,5 x 0,5	152 x 53 x 77	145 x 46 x 77	515	41,3	9003414 64028 3	9003414 68028 9	9003414 65028 2
	1,5 x 1	152 x 102 x 77	145 x 95 x 77	1060	49,9	9003414 64018 4	9003414 68018 0	9003414 65018 3
	1,5 x 1,5	152 x 152 x 77	145 x 145 x 77	1620	56,6	9003414 64048 1	9003414 68048 7	9003414 65048 0
	2 x 0,5	201 x 53 x 77	194 x 46 x 77	685	51,2	9003414 64022 1	9003414 68022 7	9003414 65022 0
	2 x 1	201 x 102 x 77	194 x 95 x 77	1450	59,8	9003414 64015 3	9003414 68015 9	9003414 65015 2
	2 x 2	201 x 201 x 77	194 x 194 x 77	2900	76,4	9003414 64035 1	9003414 68035 7	9003414 65035 0
	L 2 x 1	201 x 201 x 77	194 x 194 x 77	2180	82,6	9003414 64025 2	9003414 68025 8	9003414 65025 1

Accesorii	Pentru marimea	Dimensiuni l x L x Hl (cm)	Argintiu Metalizat	Gri cuart Metalizat	Gri Inchis Metalizat
Raft Intermediar	1 x 0,5	98 x 51 x 3	-	-	9003414 65042 8
	1 x 1	98 x 100 x 3	-	-	9003414 65046 6
	1,5 x 0,5	147 x 51 x 3	-	-	9003414 65045 9
	2 x 0,5	196 x 51 x 3	-	-	9003414 65043 5
	1,5 x 1	147 x 98 x 3	-	-	9003414 65049 7
	2 x 1	196 x 100 x 3	-	-	9003414 65047 3
Rama extinsa pentru frig	2 x 1	200 x 101 x 23	9003414 64013 9	9003414 68013 5	9003414 65013 8
Protectie impotriva melcilor	1 x 0,5	110 x 61 x 4,2	9003414 16349 2	9003414 16351 5	9003414 16350 8
	1 x 1	110 x 110 x 4,2	9003414 16370 6	9003414 16372 0	9003414 16371 3
	1,5 x 0,5	160 x 61 x 4,2	9003414 16367 6	9003414 16369 0	9003414 16368 3
	2 x 0,5	209 x 61 x 4,2	9003414 16355 3	9003414 16357 7	9003414 16356 0
	1,5 x 1	160 x 61 x 4,2	9003414 16364 5	9003414 16366 9	9003414 16365 2
	2 x 1	209 x 110 x 4,2	9003414 16352 2	9003414 16354 6	9003414 16353 9
	1,5 x 1,5	160 x 160 x 4,2	9003414 16361 4	9003414 16363 8	9003414 16362 1
	2 x 2	209 x 209 x 4,2	9003414 16373 7	9003414 16375 1	9003414 16374 4
Bordura	1 x 0,5	115 x 66,4 x 6,3	9003414 16399 7	9003414 16401 7	9003414 16400 0
	1 x 1	115 x 115 x 6,3	9003414 16396 6	9003414 16398 0	9003414 16397 3
	1,5 x 0,5	164 x 66,4 x 6,3	9003414 16393 5	9003414 16395 9	9003414 16394 2
	2 x 0,5	214 x 66,4 x 6,3	9003414 16382 9	9003414 16384 3	9003414 16383 6
	1,5 x 1	164 x 115 x 6,3	9003414 16390 4	9003414 16392 8	9003414 16391 1
	2 x 1	214 x 115 x 6,3	9003414 16379 9	9003414 16381 2	9003414 16380 5
	1,5 x 1,5	164 x 164 x 6,3	9003414 16385 0	9003414 16387 4	9003414 16386 7
	2 x 2	214 x 214 x 6,3	9003414 16376 8	9003414 16378 2	9003414 16377 5
Spalier (1 buc.) (Se poate folosi si la marimea L 1 buc.)	pentru 1 m pe o parte	102 x 4 x 91	9003414 16436 9	9003414 16438 3	9003414 16437 6
	pentru 1,5 m pe o parte	152 x 4 x 91	9003414 16439 0	9003414 16441 3	9003414 16440 6
	pentru 2 m pe o parte	201 x 4 x 91	9003414 16442 0	9003414 16444 4	9003414 16443 7
Spalier in forma L (2 buc.)	1 x 1	102 x 102 x 91	9003414 16445 1	9003414 16447 5	9003414 16446 8
	1,5 x 1,5	152 x 152 x 91	9003414 16448 2	9003414 16450 5	9003414 16449 9
	2 x 2, L 2 x 1	201 x 201 x 91	9003414 16451 2	9003414 16453 6	9003414 16452 9
Paravan (1 buc.) (Se poate folosi si la marimea L 1 buc.)	pentru 1 m pe o parte	102 x 4 x 91	9003414 16457 4	9003414 16459 8	9003414 16458 1
	pentru 1,5 m pe o parte	152 x 4 x 91	9003414 16460 4	9003414 16462 8	9003414 16461 1
	pentru 2 m pe o parte	201 x 4 x 91	9003414 16463 5	9003414 16465 9	9003414 16464 2
Spalier in forma L (2 buc.)	1 x 1	102 x 102 x 91	9003414 16466 6	9003414 16468 0	9003414 16467 3
	1,5 x 1,5	152 x 152 x 91	9003414 16469 7	9003414 16471 0	9003414 16470 3
	2 x 2, L 2 x 1	201 x 201 x 91	9003414 16472 7	9003414 16474 1	9003414 16473 4
Paravan cu panou de sticla acril (1 buc.) (Se poate folosi si la marimea L 1 buc.)	pentru 1 m pe o parte	102 x 4 x 91	9003414 16475 8	9003414 16477 2	9003414 16476 5
	pentru 1,5 m pe o parte	152 x 4 x 91	9003414 16478 9	9003414 16480 2	9003414 16479 6
	pentru 2 m pe o parte	201 x 4 x 91	9003414 16481 9	9003414 16483 3	9003414 16482 6
Paravan in forma de L cu panouri de sticla (2 buc.)	1 x 1	102 x 102 x 91	9003414 16484 0	9003414 16486 4	9003414 16485 7
	1,5 x 1,5	152 x 152 x 91	9003414 16487 1	9003414 16489 5	9003414 16488 8
	2 x 2, L 2 x 1	201 x 201 x 91	9003414 16490 1	9003414 16492 5	9003414 16491 8

Belvedere®	Marime	Dimensiuni Exterioare	Dimensiuni Interioare	Volum	Greutate	Cod EAN		
		l x L x Hl (cm)	l x L x Hl (cm)	(L)	(kg)	Argintiu Metalizat	Gri quart Metalizat	Gri Inchis Metalizat
	MINI	Inaltime: 45 cm						
	50^{MINI}	53 x 53 x 45	46 x 46 x 45	42	19,8	9003414 15888 7	9003414 15875 7	9003414 15853 5
	100^{MINI}	102 x 53 x 45	95 x 46 x 45	90	27,3	9003414 15887 0	9003414 15874 0	9003414 15852 8
	150^{MINI}	152 x 53 x 45	145 x 46 x 45	135	33,7	9003414 15885 6	9003414 15872 6	9003414 15850 4
	200^{MINI}	201 x 53 x 45	194 x 46 x 45	180	39,9	9003414 15882 5	9003414 15869 6	9003414 15847 4
	L100^{MINI}	102 x 102 x 45	95 x 95 x 45	130	38,8	9003414 15878 8	9003414 15865 8	9003414 15856 6
	L150^{MINI}	152 x 152 x 45	145 x 145 x 45	225	53,5	9003414 15877 1	9003414 15864 1	9003414 15855 9
	L200^{MINI}	201 x 201 x 45	194 x 194 x 45	315	66,5	9003414 15876 4	9003414 15863 4	9003414 15854 2
	MIDI	Inaltime: 61 cm						
	50^{MIDI}	53 x 53 x 61	46 x 46 x 61	42	23,8	9003414 15940 2	9003414 15919 8	9003414 15904 4
	100^{MIDI}	102 x 53 x 61	95 x 46 x 61	90	32,9	9003414 15939 6	9003414 15918 1	9003414 15903 7
	150^{MIDI}	152 x 53 x 61	145 x 46 x 61	135	40,6	9003414 15937 2	9003414 15915 0	9003414 15901 3
	200^{MIDI}	201 x 53 x 61	194 x 46 x 61	180	48,3	9003414 15934 1	9003414 15911 2	9003414 15898 6
	L100^{MIDI}	102 x 102 x 61	95 x 95 x 61	130	46,4	9003414 15930 3	9003414 15907 5	9003414 15891 7
	L150^{MIDI}	152 x 152 x 61	145 x 145 x 61	225	64	9003414 15929 7	9003414 15906 8	9003414 15890 0
	L200^{MIDI}	201 x 201 x 61	194 x 194 x 61	315	79,8	9003414 15927 3	9003414 15905 1	9003414 15889 4
	MAXI	Inaltime: 77 cm						
	50^{MAXI}	53 x 53 x 77	46 x 46 x 77	42	27,8	9003414 16021 7	9003414 16008 8	9003414 15953 2
	100^{MAXI}	102 x 53 x 77	95 x 46 x 77	90	38,5	9003414 16020 0	9003414 16007 1	9003414 15952 5
	150^{MAXI}	152 x 53 x 77	145 x 46 x 77	135	46,6	9003414 16018 7	9003414 16005 7	9003414 15950 1
	200^{MAXI}	201 x 53 x 77	194 x 46 x 77	180	57,5	9003414 16015 6	9003414 16002 6	9003414 15947 1
	L100^{MAXI}	102 x 102 x 77	95 x 95 x 77	130	54	9003414 16011 8	9003414 15998 3	9003414 15943 3
	L150^{MAXI}	152 x 152 x 77	145 x 145 x 77	225	73,6	9003414 16010 1	9003414 15997 6	9003414 15942 6
	L200^{MAXI}	201 x 201 x 77	194 x 194 x 77	315	93	9003414 16009 5	9003414 15996 9	9003414 15941 9
Accesorii	Pentru marimea		Dimensiuni l x L x H (cm)		Argintiu Metalizat	Gri quart Metalizat	Gri Inchis Metalizat	
Protectie impotriva melcilor	100	110 x 61 x 4,2		9003414 16349 2	9003414 16351 5	9003414 16350 8		
	150	160 x 61 x 4,2		9003414 16367 6	9003414 16369 0	9003414 16368 3		
	200	209 x 61 x 4,2		9003414 16355 3	9003414 16357 7	9003414 16356 0		
Fusta	50	66,4 x 66,4 x 6,3		9003414 16402 4	9003414 16404 8	9003414 16403 1		
	100	115 x 66,4 x 6,3		9003414 16399 7	9003414 16401 7	9003414 16400 0		
	150	164 x 66,4 x 6,3		9003414 16393 5	9003414 16395 9	9003414 16394 2		
	200	214 x 66,4 x 6,3		9003414 16382 9	9003414 16384 3	9003414 16383 6		
	L100	115 x 115 x 6,3		9003414 16414 7	9003414 16416 1	9003414 16415 4		
	L150	164 x 164 x 6,3		9003414 16411 6	9003414 16413 0	9003414 16412 3		
	L200	214 x 214 x 6,3		9003414 16405 5	9003414 16407 9	9003414 16406 2		
Insert pentru Ghiveci	1 bucata	50 x 50 x 18			9003414 16424 6			
	2 bucata	50 x 50 x 18			9003414 16427 7			
	3 bucata	50 x 50 x 18			9003414 16430 7			
	4 bucata	50 x 50 x 18			9003414 16433 8			
Spalier (1 buc.) (Se poate folosi si la marimea L 1 buc.)	100	102 x 4 x 91		9003414 16436 9	9003414 16438 3	9003414 16437 6		
	150	152 x 4 x 91		9003414 16439 0	9003414 16441 3	9003414 16440 6		
	200	201 x 4 x 91		9003414 16442 0	9003414 16444 4	9003414 16443 7		
Spalier in forma L (2 buc.) (pentru fiecare din partile lungi)	L100	102 x 102 x 91		9003414 16445 1	9003414 16447 5	9003414 16446 8		
	L150	152 x 152 x 91		9003414 16448 2	9003414 16450 5	9003414 16449 9		
	L200	201 x 201 x 91		9003414 16451 2	9003414 16453 6	9003414 16452 9		
Paravan (1 buc.) (Se poate folosi si la marimea L 1 buc.)	100	102 x 4 x 91		9003414 16457 4	9003414 16459 8	9003414 16458 1		
	150	152 x 4 x 91		9003414 16460 4	9003414 16462 8	9003414 16461 1		
	200	201 x 4 x 91		9003414 16463 5	9003414 16465 9	9003414 16464 2		
Spalier in forma L (2 buc.) (pentru fiecare din partile lungi)	L100	102 x 102 x 91		9003414 16466 6	9003414 16468 0	9003414 16467 3		
	L150	152 x 152 x 91		9003414 16469 7	9003414 16471 0	9003414 16470 3		
	L200	201 x 201 x 91		9003414 16472 7	9003414 16474 1	9003414 16473 4		
Paravan cu panou de sticla acril (1 buc.) (Se poate folosi si la marimea L 1 buc.)	100	102 x 4 x 91		9003414 16475 8	9003414 16477 2	9003414 16476 5		
	150	152 x 4 x 91		9003414 16478 9	9003414 16480 2	9003414 16479 6		
	200	201 x 4 x 91		9003414 16481 9	9003414 16483 3	9003414 16482 6		
Paravan cu panou de sticla in forma de L (2 buc.) (pentru fiecare din partile lungi)	L100	102 x 102 x 91		9003414 16484 0	9003414 16486 4	9003414 16485 7		
	L150	152 x 152 x 91		9003414 16487 1	9003414 16489 5	9003414 16488 8		
	L200	201 x 201 x 91		9003414 16490 1	9003414 16492 5	9003414 16491 8		

DaVinci®	Versiunea		Dimensiuni Exterioare	Cod EAN		
			I x L x HI (cm)	Argintiu Metalizat	Gri cuart Metalizat	Gri Inchis Metalizat
	1	Margine terasa cu spalier: 1,5 x 1,5 m colt cu spalier, pe ambele margini 0,5 m MIDI, 1 m MINI	299,5 x 299,5 x 168	9003414 17335 4	9003414 17346 0	9003414 17345 3
	2	Margine terasa cu paravan: 1,5 m MAXI cu paravan 1 x 1 m colt cu spalier pe o parte 0,5 m MIDI, 0,5 m MINI	250 x 201 x 168	9003414 17347 7	9003414 17349 1	9003414 17348 4
	3	Jardiniera: 0,5 m MINI, 0,5 m MIDI si 1 m MAXI	201 x 53 x 77	9003414 17350 7	9003414 17352 1	9003414 17351 4

Configureaza-ti propriul sistem DaVinci® acum! www.biohort.com/configurator

Ajutoare gradinarit

MonAmi®	Dimensiuni Exterioare	Dimensiuni interioare	Volum	Greutate	Cod EAN
	I x L x HI (cm)	I x L x HI (cm)	(L)	(kg)	Gri Inchis Metalizat
	102 x 102 x 84	95 x 95 x 74	725	62,9	9003414 65026 8

Charly®	Marime	Dimensiuni Exterioare	Greutate	Cod EAN
		I x L x HI (cm)	(kg)	
	2	78 x 90 x 49	13,5	9003414 68082 1

WoodStock®	Marime	Dimensiuni Exterioare*	Dimensiuni interioare	Dimensiunile fundatiei	Volum	Greutate	Cod EAN		
		I x L x HI (cm)	I x L (cm)	I x L (cm)	(m³)	(kg)	Argintiu Metalizat	Gri cuart Metalizat	Gri Inchis Metalizat
	150	157 x 102 x 199	142 x 70	155 x 83	2,1	48,5	9003414 35010 6	9003414 38010 3	9003414 37010 4
	230	229 x 102 x 199	214 x 70	227 x 83	3,1	54,1	9003414 35020 5	9003414 38020 2	9003414 37020 3
	300	300,7 x 102 x 199	286 x 70	299 x 83	4	64,7	9003414 35040 3	9003414 38040 0	9003414 37040 1
Accesorii	Pentru marimea	Dimensiuni I x L x H (cm)							
Panou podea din aluminiu	150	141,5 x 69,5 x 0,2			9,9		9003414 48010 0		
	230	213,5 x 69,5 x 0,2			14		9003414 48080 3		
	300	285,5 x 69,5 x 0,2			17,3		9003414 48013 1		
Perete spate	150	145,5 x 1,1 x 196,5			15,7	9003414 35012 0	9003414 38012 7	9003414 37012 8	
	230	217,5 x 1,1 x 196,5			22,5	9003414 35022 9	9003414 38022 6	9003414 37022 7	
	300	288,6 x 1,1 x 196,5			32,9	9003414 35042 7	9003414 38042 4	9003414 37042 5	
Pachet usa	150	157 x 5 x 171			24	9003414 35001 4	9003414 38001 1	9003414 37001 2	
	230	229 x 5 x 171			29	9003414 35002 1	9003414 38002 8	9003414 37002 9	
Nota: Daca rama de fixare se aseaza direct pe baza de pietris (aprox. 10 cm pietris fara fundatie) este necesara utilizarea ancorelor pentru fixare. Rezistenta la furtuna trebuie asigurata de catre client, pentru marimile 150, 230: 6 buc. in total, pentru marimea 300: sunt necesare 10 buc. in total.									
Surub de ancorare sol	4 bucati per pachet						9003414 41004 6		
	6 bucati per pachet						9003414 41006 0		

*cel mai inalt punct, inclusiv limita acoperisului

Agenti de curatare CleanLine

CleanLine			Volum	Cod EAN
	Agent de curatare universal	Puternic impotriva grasimii, uleiului si murdariei de orice fel. Formeaza o suprafata care protejeaza impotriva murdariei (efectul lotus). Perfect pentru a sterge urmele de maini dupa asamblare.	1000 ml	9003414 99000 5
	Pastrarea	Iti protejeaza produsul Biohort impotriva influentelor mediului si iti asigura in acelasi timp un luciu placut.	750 ml	9003414 99100 2
	Set	(Curata + Pastreaza)	1000 ml + 750 ml	9003414 99200 9

Paravan

Paravan fara panouri din acril	Marime	Dimensiuni Exterioare		Greutate	Cod EAN		
		l x L x Hl (cm)		(kg)	Argintiu Metalizat	Gri cuart Metalizat	Gri Inchis Metalizat
Inaltime : 90 cm							
Consta din panouri si doua sine de ghidaj pentru asamblare intre doua paravane, se poate atasat la casa sau alt ceva similar							
	100 x 90	96 x 4,4 x 91		13,2	9003414 15924 2	9003414 15920 4	9003414 15892 4
	150 x 90	145 x 4,4 x 91		17,7	9003414 15925 9	9003414 15921 1	9003414 15893 1
	180 x 90	180 x 4,4 x 91		21,5	9003414 15926 6	9003414 15922 8	9003414 15894 8
	200 x 90	194 x 4,4 x 91		22,9	9003414 15928 0	9003414 15923 5	9003414 15917 4
Inaltime : 135 cm							
Consta din panouri si doua sine de ghidaj pentru asamblare intre doua paravane, se poate atasat la casa sau alt ceva similar							
	100 x 135	96 x 4,4 x 137		20,3	9003414 15981 5	9003414 15977 8	9003414 15973 0
	150 x 135	145 x 4,4 x 137		27,2	9003414 15982 2	9003414 15978 5	9003414 15974 7
	180 x 135	180 x 4,4 x 137		33,4	9003414 15983 9	9003414 15979 2	9003414 15975 4
	200 x 135	194 x 4,4 x 137		35,5	9003414 15984 6	9003414 15980 8	9003414 15976 1
Inaltime : 180 cm							
Consta din panouri si doua sine de ghidaj pentru asamblare intre doua paravane, se poate atasat la casa sau alt ceva similar							
	100 x 180	96 x 4,4 x 182		25,7	9003414 16046 0	9003414 16042 2	9003414 16038 5
	150 x 180	145 x 4,4 x 182		34,7	9003414 16047 7	9003414 16043 9	9003414 16039 2
	180 x 180	180 x 4,4 x 182		42,3	9003414 16048 4	9003414 16044 6	9003414 16040 8
	200 x 180	194 x 4,4 x 182		45,1	9003414 16049 1	9003414 16045 3	9003414 16041 5
Paravan cu panouri din acril							
Paravan cu panouri din acril	Marime	Dimensiuni Exterioare		Greutate	Cod EAN		
		l x L x Hl (cm)		(kg)	Argintiu Metalizat	Gri cuart Metalizat	Gri Inchis Metalizat
Inaltime: 90 cm							
Consta din panouri, panou de sticla si doua sine de ghidaj pentru asamblare intre doua paravane, se poate atasat la casa sau alt ceva similar							
	100 x 90	96 x 4,4 x 91		13,1	9003414 15969 3	9003414 15965 5	9003414 15961 7
	150 x 90	145 x 4,4 x 91		17,7	9003414 15970 9	9003414 15966 2	9003414 15962 4
	180 x 90	180 x 4,4 x 91		21,1	9003414 15971 6	9003414 15967 9	9003414 15963 1
	200 x 90	194 x 4,4 x 91		22,3	9003414 15972 3	9003414 15968 6	9003414 15964 8
Inaltime: 135 cm							
Consta din panouri, panou de sticla si doua sine de ghidaj pentru asamblare intre doua paravane, se poate atasat la casa sau alt ceva similar							
	100 x 135	96 x 4,4 x 137		20,2	9003414 16034 7	9003414 15989 1	9003414 15985 3
	150 x 135	145 x 4,4 x 137		27,2	9003414 16035 4	9003414 15990 7	9003414 15986 0
	180 x 135	180 x 4,4 x 137		33	9003414 16036 1	9003414 15991 4	9003414 15987 7
	200 x 135	194 x 4,4 x 137		34,9	9003414 16037 8	9003414 15992 1	9003414 15988 4
Inaltime: 180 cm							
Consta din panouri, panou de sticla si doua sine de ghidaj pentru asamblare intre doua paravane, se poate atasat la casa sau alt ceva similar							
	100 x 180	96 x 4,4 x 182		25,6	9003414 16058 3	9003414 16054 5	9003414 16050 7
	150 x 180	145 x 4,4 x 182		34,7	9003414 16059 0	9003414 16055 2	9003414 16051 4
	180 x 180	180 x 4,4 x 182		41,9	9003414 16060 6	9003414 16056 9	9003414 16052 1
	200 x 180	194 x 4,4 x 182		44,5	9003414 16229 7	9003414 16057 6	9003414 16053 8
Stalp pentru Paravan							
Stalp pentru Paravan	potrivit pe inaltime	Inaltime min. Inaltime max.	Placa de la baza*	Greutate	Cod EAN		
			l x L (cm)	(kg)	Argintiu Metalizat	Gri cuart Metalizat	Gri Inchis Metalizat
Stalp pentru ancorare							
Sunt fixate in sol. Pentru ancorare la suprafata, stalpii se pot folosi ca incepere, final, colt sau conectare pentru panouri. Alegeți panou paravan care se potriveste cu inaltimea stalpului! Diametru: 10 cm. Un stalp per articol.							
	90 cm	95-120	15 x 15	10,5	9003414 16342 3	9003414 16341 6	9003414 16340 9
	135 cm	140-165	15 x 15	11,4	9003414 16345 4	9003414 16344 7	9003414 16343 0
	180 cm	185-210	15 x 15	13,1	9003414 16348 5	9003414 16347 8	9003414 16346 1
Stalp pentru fixare in beton							
Sunt integrati in fundatia punct. Pentru ancorare la suprafata, stalpii se pot folosi ca punct de pornire de start, final, colt sau conectare pentru panouri. Alegeți panou paravan care se potriveste cu inaltimea stalpului! Diametru: 10 cm. Un stalp per articol.							
	90 cm	95-120		10,2	9003414 17336 1	9003414 17342 2	9003414 17339 2
	135 cm	140-165		11,7	9003414 17337 8	9003414 17343 9	9003414 17340 8
	180 cm	185-210		13,8	9003414 17338 5	9003414 17344 6	9003414 17341 5
Accesorii montaj							
Pentru stalpii de ancorare							Cod EAN
Bit burghiu percutor	Bormasina se foloseste pentru a face gaurile necesare in beton pentru mortarul pentru fixare. Bormasina este disponibila la magazinele de specialitate.					SDS plus Ø14 mm Lungime: 150 mm	9003414 18784 9
Pistol Cu Aer Si Perie De Curatat	Pistolul se foloseste pentru curatarea usoara si sigura a gauri. Peria de curatare se foloseste pentru a inlatura praful de langa gauri. Acest lucru asigura aderenta mortarului la fundatia din beton.						9003414 18785 6
Tub cu Mortar pentru fixare	Tub cu mortar pentru fixare este necesar pentru a asigura fixarea in beton.					Continut 300 ml Suficient pentru maxim 16 buc. Surub ancorare M12 X 160	9003414 18782 5
Pistol Aplicator	Mortarul pentru fixare se aplica precis cu pistolul aplicator. Aceasta se obtine prin transmisia fara eforturi.					Cartuse potrivite de 310 ml	9003414 18783 2
Sistem Ancorare Cu Filet	Surubul ancora cu filet este lipit in fundatie si garanteaza o fixare sigura intre fundatie si paravanul Biohort, inclusiv baza. 4 buc.per Articol - suficient pentru un stalp.					M12 x 160 R include piulite si saibe	9003414 18786 3

*Placa de acoperire are dimensiunile 18 x 18 cm.



Case de gradina

Ne bazam pe calitate si longevitate



CUTII PENTRU DEPOZITARE EXTERIOR

Cutii de depozitare outdoor pentru gradina, curte & etc.



Depozitare bicicleta

Biciclete, scutere &etc protejate in siguranta



Depozitare pubele

Cu stil, practice si fara sa necesite mentenanta



Ajutoare gradinarit

Designul de gradina in cea mai buna varianta

Dealerul tau specializat:



biohort®

Biohort
inseamna
"Viata in
gradina"

Aici gasiti
preturile noastre
recomandate de
retail

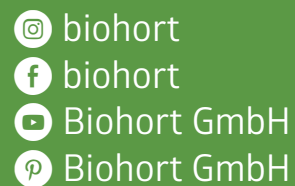

follow us:



Biohort GmbH
Pürnstein 43, 4120 Neufelden, Austria
+43 7282 / 7788 0
office@biohort.at
www.biohort.com

Cu rezerva: modificari tehnice, erori de
tipar, deviatii de culoare.
ZD101180 - RO